

azimuth and angular altitude, a_1 and h_1 , of the cloud are immediately measured with a theodolite; then the azimuth and angular altitude of the sun, a_2 and h_2 , are measured; these are to be corrected when necessary for the slight change in the position of the cloud and sun during the time elapsing between the first and second observations; then the azimuth, a_3 , and distance, b , of the cloud shadow are measured, as seen on the ground when the first observation was taken. The distance is taken from a map, of which we have a number, detailed, accurate, and on a large scale for the region around Blue Hill.

A moment's consideration will show that the measurement of the azimuth and angular altitude of the sun from Blue Hill takes the place of an observation of the sun and cloud with a theodolite at the position of the cloud shadow. For if an observer were at that point and looked toward the cloud he would find it exactly in the direction of the sun, and since the rays of the sun are practically parallel, he would get the same angular altitude and azimuth as that measured by observing on the sun from Blue Hill. Hence, by making the measurements of a_2 and h_2 from Blue Hill alone, we get the same results as if we had observers looking at the cloud simultaneously from the two ends of a base line, and the formulæ for calculating the results are the well-known trigonometrical relations:

$$A_1 = a_1 - a_2; \quad z_1 = b \sin A_1 \operatorname{cosec} A \tan h_1$$

$$A_2 = a_2 - a_3; \quad z_2 = c + z_1 = b \sin A_1 \operatorname{cosec} A \tan h_2$$

$$A = a_1 - a_3; \quad z_m = \frac{1}{2} (z_1 + z_2 - c)$$

This formula gives the mean altitude of the cloud above Blue Hill (z_m) from the results calculated from the two ends of a base line drawn from the lower station or shadow to a point below the upper station; c is the difference in level between the stations, and must be read off from the map by means of the contour lines, if the country is not quite level. The relations of the angles to each other in the above formulæ, and the agreement of the calculated heights z_1 and $z_2 - c$, furnish criteria¹ for determining the accuracy of the observations and for preventing errors which might arise, for example, from taking the angular measurements on one cloud, while by mistake using the shadow of another.

The following table gives the results of measurements made on a cumulus cloud on May 19, 1896. The heights in the second to the fifth columns were determined parallaxically by two observers with theodolites observing simultaneously at the ends of the base line. The mean of their four results is given in the sixth column. The height given in the seventh column was determined a few minutes later (at

Time	Theodolite method.				Mean	Cloud shadow method.
	8 ^h 27 ^m	8 ^h 28 ^m	8 ^h 29 ^m	8 ^h 30 ^m		
Calculated height in meters ..	961	967	972	980	968	958

8:51 a. m.) by means of cloud shadows; evidently the two methods give practically the same results.

The base of the nearly uniform stratus or nimbus, measured by kites, is, I think, lower as a physical reality than the broken sheets of the same clouds, the only kinds which permit of measurement with theodolites.

Example illustrating the method of computation by the above formulæ.
Distance of shadow $b = 4,432$ meters; shadow below Blue Hill $c = 44$ meters.

Time	2 ^h 53 ^m p. m.	$\log \tan h_1$	9.6286	Z_2	1,543 meters
Cloud	8. 00.	$\log \sin A_2$	9.7280	c	44 meters
$A_1 = a_1 - a_2$	108.00°	$\log b$	3.6515	$Z_2 - c$	1,499 meters
$A_2 = a_2 - a_3$	148.10°	$\log \operatorname{cosec} A$	0.1737	Z_1	1,455 meters
$A = a_1 - a_3$	42.10°	$\log \sin A_1$	9.9688	Diff.	44 meters
h_1	23.50°	$\log \tan h_2$	9.3808	Z_m	1,455 meters
h_2	13.50°	$\log Z_1$	3.1718		
		$\log Z_2 = Z_1 + c$	3.1883		

¹See note by the Editor on "Cloud Heights."

THE MECHANICS AND EQUILIBRIUM OF KITES.*

A monograph prepared by C. F. Marvin, Professor of Meteorology, U. S. Weather Bureau, submitted with the approval of Prof. Willis L. Moore, Chief of Weather Bureau, in competition for the "Chanute Prize" offered by the Boston Aeronautical Society.

ANNOUNCEMENT OF PRIZE.

Octave Chanute, Esq., ex-president of the American Society of Civil Engineers, generously offers the prize herein described.

Under date of May 27, 1896, he writes to the Society as follows: "I herewith enclose \$100, and authorize the Boston Aeronautical Society to offer this sum as a special prize for the best monograph on the kite, giving a full theory of its mechanics and stability, with quantitative computations appended.

"This prize to be awarded by judges appointed by the Society. It may be withheld one year in case no sufficiently complete monograph is handed in.

"To explain the latter reservation, it may be suggested that the following points need consideration:

"1. The resolution of all the forces acting upon an ordinary kite with a tail; i. e., the wind pressure upon its surface, its tail, and its string, and the weight (gravity) of these various parts. The resulting equilibrium, or the diving, spinning round, or glancing sideways, and how the forces act which restore the balance. State the position of the center of gravity, center of pressure, and best point of attachment for the string, with numerical example.

"2. Give the same elements for the tailless kite, distinguishing between the Malay, the Japanese or Chinese, the Bi-polar, the Hargrave, and the Fin (Boynton) kites. Indicate also what are the general principles upon which each group of the tailless kites depends for its stability.

"3. What effect is produced by changes in the point of attachment of the string, and what is the pull thereon with various positions and with various strengths of wind.

"4. What is the difference in effect between the kite string and the attraction of gravity on the mass of a soaring bird.

"Sincerely yours, O. CHANUTE."
Competitors for this prize are requested to have their essays typewritten, and to send them in on or before November 15, 1896.

Address Secretary of the Boston Aeronautical Society, P. O. Box 1197, Boston, Mass., U. S. A.

CONTENTS.

	Section.
Introduction	I
Definitions and axiomatic statements	II
General statement	III
Forces acting on kites in general	IV
Circumstances of equilibrium and motion	V
Explanation of the flight of kites	VI
Abnormal flight of kites	VII
Effects of changes in wind and position of kite	VIII
Conditions of stability and steadiness of kites	IX
Numerical data	X
The mechanics of the kite string	XI
Properties of the catenary	XII

I.—INTRODUCTION.

Since our purpose is to present in full a theory of the mechanics and stability of kites in general, it will be well at the outset to clearly define the essential and fundamental conception that we consider to be conveyed or suggested by the word kite. Furthermore, the behavior of kites, however diverse in character and detail, results from the action and reaction of a small number of well known natural forces. Some of the forces that we must consider act upon the kite itself, while others, in a wholly independent manner, act upon the string or line employed to restrain the kite. Very important limitations to the attainments of which kites are capable arise wholly in consequence of the action of forces upon the string. Under these circumstances it will be most logical, after defining the kite, to consider without regard to any particular or specialized form of kite, those general and fundamental principles of physics and mechanics that underlie the action of all kites and study that relation of forces which is essential

*The above monograph, by Professor Marvin, was awarded the "Chanute Prize" by the judges appointed by the Boston Aeronautical Society, which society has also submitted it for publication in the MONTHLY WEATHER REVIEW.

to their flight and stability. In these studies we shall be led, also, to develop separately the results of the action of the forces on the string.

In order, finally, to give due consideration to the points specified under items 1 to 4, inclusive, in the announcement of the Chanute prize, it will suffice to apply the general theory that we shall first present to the several individual cases, pointing out the particular application and developing any special features that may arise.

II.—DEFINITIONS AND AXIOMATIC STATEMENTS.

Kite.—Fundamentally a kite is a surface or series of surfaces, either flat or curved, which are provided with a restraining attachment having the nature of a string or line. The surfaces and line are arranged in such relations that when the kite, held in restraint by the line, is exposed to masses of air in motion, the surfaces are subjected to wind pressures which sustain the kite in mid-air, where it assumes a position of equilibrium.

Ideal and actual kites distinguished.—Occasion will arise in our study of the mechanics of the kite to consider the results that follow when various defects and imperfections, generally found in kites, are absent. It will be desirable, therefore, to clearly distinguish at all times between what we shall call the *perfect* or *ideal kite*, from which all defects and imperfections are wholly absent, and the *actual* or *material kite*, which is always unavoidably trammelled by greater or less defects and imperfections. If the kite is a surface against which it is designed the wind shall press, then the ideal kite is that surface; the actual kite is a material substance having thickness, weight, edges, possibly a tail, etc.

The string, or kite line, or simply line, as we shall generally call it, is a subordinate accessory to the kite, and is unessential in so far as the mechanics of the kite is concerned. The specific function of the line is to hold the kite in restraint, and while doing so to assume without opposition any direction essential to the kite's equilibrium. It is conceivable that all the phenomena incident to the stability of a kite can be exhibited without the use of a string, as, for example, by securing the kite to the top of a suitable pole or mast by means of a connector in the nature of a universal joint. The only object in presenting this thought is to emphasize the essential independence of the kite and the string, so far as the mechanics of the former is concerned.

The ideal kite string is a flexible, inextensible, mathematical line, which has unlimited strength and is without weight or thickness. The actual material kite line is, in general, sufficiently flexible, but its weight and thickness, and sometimes its roughness are objectionable, and its strength is limited.

Bridle.—The bridle is a subordinate, often not an essential accessory of the kite. Its purpose is to provide a point for the attachment of the restraining line to the kite, such that certain relations are permitted between the restraining forces acting in the line and the forces of the wind pressure and gravity acting upon the kite. The bridle may also be made to serve a secondary purpose, as follows: The resultant pull, due to all the forces acting upon the kite, is accumulated and transmitted to the line through the bridle. In addition, therefore, to serving its normal function, as stated above, the bridle may incidentally be made to distribute the strains upon certain members of the framework of the kite in such a manner that they can safely sustain greater strains than might be the case without the bridle.

Pull, lift, drift, tension.—In referring to the strain upon the kite line which tends to tear it asunder we shall employ the words pull or tension, and when so used the words will be considered synonymous. *Lift* is the vertical and *drift* the horizontal component of the *pull*. We may logically deal

with the pull, lift, and drift, not alone at the kite, but likewise at any point along the line. If at a given point the inclination of the kite line to the horizontal is the angle θ , and the tension is t , then the *lift* equals $t \sin \theta$, and the *drift* equals $t \cos \theta$.

Tail.—Some kites can not preserve their equilibrium without the assistance of a tail; with others it is unnecessary, although a tail may be applied to any kite. When present, the kite is subjected to the action of one more force than would otherwise be the case. This force is the resultant of the action of gravity and the wind upon the tail.

III.—GENERAL STATEMENT.

The flight of any conceivable kite and the motions it may execute—including, for example, the general case of a faulty and insubordinate member of a tandem, which, being held at a comparatively fixed point high up in the free air, can not end its erratic flight in a precipitate dash to the ground, but must go on and execute any orderly or disorderly movements the circumstances may demand, even if it be broken and distorted—all possible evolutions of such a kite or of any other, under any and all circumstances, find their full explanation in the application of the following general proposition of mechanics, the full demonstration of which is to be found in the ordinary text books:

Any system of forces acting upon a rigid body may always be reduced to a single resultant force, R_0 , having a definite and determinate position and a resultant couple, Z_0 , the forces of which act in a plane perpendicular to the force R_0 . The force and couple can, together, produce exactly the same effects as the system.

The kite is a body which is rigid within the present meaning, and, when flying, is acted upon by a complex system of forces. The conditions of equilibrium or motion are these:

When the couple $Z_0=0$, and when the string pulls in a direction opposite to the force R_0 , and exactly in line with it, then the kite will be in equilibrium. If, however, the couple Z_0 is finite, while the string constantly neutralizes the force R_0 , then the kite will spin around upon the string as an axis of rotation, the kite as a whole remaining fixed in one position. If on the other hand, the pull of the string does not balance the force R_0 , but the couple Z_0 still remains zero, then the kite will be translated in some direction without rotation. Finally, if Z_0 be finite and the force R_0 is unneutralized by the restraint of the string, then the kite will be both translated and will also rotate about the string as an axis. All the evolutions any kite may execute are but combinations of the foregoing cases, as will be more fully discussed hereafter.

While we may thus, by the fundamental propositions of mechanics, pass at a single step from the conception of the highly complex system of forces due to the action of wind and gravity upon every point and particle of the kite to its exceedingly simple equivalent, and establish all the circumstances of motion or rest, by doing so we omit from consideration many relations between the forces of the system that are of great practical importance and utility, especially in the designing and constructing of kites to perform any assigned duty.

Before discussing, therefore, in full, the specific causes of the various motions kites are observed to execute, we will analyze in detail the forces acting upon kites in general.

IV.—FORCES ACTING ON KITES IN GENERAL.

In flight, the forces acting upon a kite and its line are: (1) The total of all the wind pressures upon the whole structure, including pressures upon not only the sustaining surfaces but upon every part of the framework, also all friction effects of the wind gliding over the surfaces, etc.; (2) The attraction of gravity for the kite; (3) The tension of the string at the kite, that is, the restraining pull of the line;

(4) The attraction of gravity for the string; (5) The pressure of the wind upon the string; (6) The action and reaction of the forces at the reel that restrain the whole system. If the kite is provided with a tail, one more composite force acts in addition to the six mentioned above, namely, (7) the resultant of the forces of the wind (W) and gravity (G) upon the tail. When a kite, or tandem of kites, is employed to lift and sustain objects in mid-air, such as meteorological instruments, photographic apparatus, etc., these may be attached to the kite frame itself, in which case the pressure of the wind against the object and its weight may logically be considered with the forces (1) and (2) above. It is not, however, customary, as a rule, to carry such loads in this way. The apparatus is generally suspended from the line at some point below the top end. In this case the forces of wind (a) and gravity (b) acting upon the attachments are properly considered in connection with the other forces (4), (5), and (6) acting upon the string. If the forces (wind and gravity) acting upon the short piece of string or line employed to suspend the instruments are not inappreciable, then those forces, also, if not included in (a) and (b) above, must be treated separately.

Under the circumstances cited all of these forces are concerned in determining the positions of equilibrium assumed by a kite flying freely in mid-air. In studying the mechanics of the kite proper, however, we are concerned only with the equilibrium of the forces (1), (2), and (3), including (7), if the kite has a tail. We need to consider the string and the forces acting thereon only when we wish to know how high a given kite can fly, or the position it will assume when carrying a given load with a certain length of line, etc.

Having thus called attention in a general way to all the forces upon which the action of any kite depends, we will omit from present consideration the string and its forces and proceed first to develop the relations upon which the equilibrium of the kite itself depends, that is, the relations between the forces (1), (2), (3), and (7).

In order that the reader may form a mental picture of just what we now desire to consider, he may imagine a kite in mid-air under conditions of free exposure to the wind but held in restraint by a comparatively short piece of string or line. The action of gravity and the wind upon this short line being inappreciable, it will therefore be sensibly straight. The direction in which this string is pulled; the inclination of the surfaces of the kite to the wind; the action of the tail, when present; the variations of the several forces with changes in the character of the wind; the process by which the kite once in equilibrium is able to reestablish equilibrium under constantly changing conditions of the wind—are the questions with which we are now concerned.

The force (2) is wholly and simply a gravitation effect, and is, therefore, perfectly constant in amount and direction. The tension in the short piece of restraining line and its direction constitute the restraining force (3) which always acts through the point at which the line is fastened to the bridle or kite stick, as the case may be. This force (3) is not an independent force; it exists and undergoes variations only as a result of the action and variation of the other forces specified. Of the remaining forces, (1) is wholly and (7) partly a wind effect of comparatively complex character and subject to variations of great frequency and very considerable magnitude. In order to set forth fully the effects of the wind pressure upon the kite, as we now imagine it flying upon a short straight string, it will be necessary to analyze in some detail the nature and composition of the forces (1) and (7), which together embrace the total effect of the wind upon the kite and its tail. We are particularly concerned with (1) which includes by far the most important forces with which we have to deal. For the purpose of this analysis it will be

convenient to classify the several portions of the kite structure, as follows: Sustaining surfaces; framework; edges; neutral surfaces; and finally the tail, which consistently belongs within this classification, notwithstanding that the forces acting thereon have already been specified under (7). In some specialized and uncommon forms of kites perhaps portions of the structure may not fall within this classification; it will suffice, however, for our present purposes, as we seek to show only the ultimate effect resulting from the pressure of the wind upon the entire structure of the kite. We embrace under "sustaining surfaces" all those extended surfaces of cloth, paper, or similar material whose normal function is to sustain the kite as a result of the pressure of the wind thereon. In many forms of kites, especially of oriental types, we find the most remarkable diversities in the shapes of the supporting surfaces. The logical inference we may draw from this diversity of itself is that the mere shape of the surface is of little importance. As we shall see, the continued flight of kites depends upon the action of certain forces, one of which is the pressure of the wind against surfaces. There is scarcely any limitation to the form of surface that may be used. The necessary force is produced and can be made to act in proper relation to the other forces with almost any surface whatsoever.

The framework, in the present classification, includes all the sticks, struts, ties, braces, and those members of the structure that spread out the sustaining surfaces and give form to the kite. The group entitled "edges," includes principally any exposed edges of the cloth or covering material. These are usually reinforced by a hem, or otherwise thickened, often with the addition of a cord within the hem. While the wind pressure upon such "edges" will generally be relatively unimportant, yet it is very proper to recognize them in our analysis. Finally, an example of neutral surfaces is found in the fin or keel of the Boynton kite, and in the lateral surfaces of the rectangular cells of a Hargrave kite.

Primary characteristics of wind pressures.—It is well known that the pressure experienced by any object exposed to the action of the wind is due not alone to the direct impact of the air on the front or windward surface, but also to the diminution in the static pressure over the back surface or lee side of the object. For our present purposes we need not push the analysis so far as to separate these effects, and we will in all cases regard them as combined into one resultant pressure exerted against the front side of the object under consideration. In dealing with surfaces exposed to pressure we wholly disregard the edges. The effect of pressure upon the edges is reserved for separate consideration.

Whenever the wind encounters a perfectly smooth surface which causes a change in the direction of motion of the current, the surface experiences a pressure which acts exactly normal to every element affected. This is a fundamental and well known principle of hydrodynamics and finds important application in the theory of the kite.

In the case of slightly roughened, fuzzy surfaces, such as the cloth used in kites, the surface can not be regarded as perfectly smooth, and there will in consequence be a friction effect resulting from the flow of the particles of air over such rough surfaces. The air may be regarded as pressing against the minute projections and irregularities which constitute the roughness of the surface, and a relatively slight force is thereby developed which tends to urge the surface along in the direction in which the streams of air are flowing over it. This effect of skin friction combined with the pressure normal to the surface gives the total effect of the wind on the supposed roughened surface. Obviously, this total effect is a pressure which is not quite normal to the surface but will be inclined thereto more or less in proportion to the relative magnitude of the friction effect. Having thus recog-

nized and assigned the proper place to the effects of skin friction, it will scarcely be necessary to give it further consideration, since, as is well known, the effect is so small, relative to the principal forces acting on kites, as to be quite unimportant. Without further mention, therefore, we will hereafter consider that the slight effect due to friction is included with the normal pressure against the surface. Furthermore, we will still designate this combined effect as the *normal pressure* since in practical cases it will be sensibly perpendicular to the surface.

Pressure upon sustaining surfaces.—In accordance with the characteristics of wind pressures, as enunciated above, the whole effect of the wind's action upon the sustaining surfaces, either flat or curved, of any form of kite whatever, consists of a pressure sensibly normal to the surface at every point.

Flat surfaces.—If the sustaining surfaces are flat, the normal pressures are parallel to each other, and the total effect of all the individual pressures may be represented by a single force or pressure acting sensibly normal to the supposed flat surface and at a point commonly called the center of pressure, which is a point through which the resultant force must act to produce the same effect as the individual pressures.

Curved or arched surfaces.—The sustaining surfaces of kites, being generally formed of yielding materials, such as cloth or paper, will, whether designedly or not, form curved surfaces when pressed by the wind. This curvature will sometimes be wholly in one direction, either coincident with the direction of the flow of the particles of air across the surface or at right angles thereto; whereas in many cases the surface will be curved in all directions. In any case the individual pressures at elementary points upon such surfaces must still be regarded as sensibly normal at each point, but the direction of the resultant pressure can rarely or never be fully assigned by any of the principles of hydrodynamics thus far established. The direction may be partly predetermined by known laws in some cases, but, in general, it can be fully established only by aid of experimental investigations. This is especially the case when the surface is curved in the direction in which the particles of air flow across it. Data of this character are comparatively scanty and incomplete, often obtained by erroneous methods, so that we can not, even from experimental results, definitely assert more than a few general conclusions relative to the pressure of wind upon arched surfaces. Much has been written upon this subject, and especially upon the asserted property of "aspiration," by virtue of which the pressure of a *horizontal* wind upon a properly disposed arched surface is able not only to sustain it, but also to propel it forward. Such a remarkable performance is undoubtedly in direct violation of the fundamental laws of nature, and, in the numerous cases where it is claimed not only that birds in the free air have been certainly observed to exhibit aspiration, but that these effects have likewise been fully reproduced with artificial free-flying models, it is easy to show that these claims are wholly unsupported by any evidence that the wind was strictly in the *horizontal* motion virtually assumed. Lack of proof on this point alone is fatal to the claim that any case of real aspiration has been observed or reproduced. Lilienthal, Langley, Maxim, Wellner, F. von Loessel, and others have conducted extensive experimental investigations upon aerodynamic problems, but, as far as known to the writer, the results of several of these investigations have been only partly published up to the present time. The most completely published results of wind effects upon arched surfaces is found in Lilienthal's book¹ and in a pamphlet by Wellner.²

¹Der Vogelflug als Grundlage der Fliegekunst. Von Otto Lilienthal. Berlin, 1889.

²Versuche über den Luftwiderstand gewölbter Flächen in Winde und auf Eisenbahnen. Von Georg Wellner. Zeitschrift für Luftschiffahrt. Beilage zu Heft X. Berlin, October, 1893.

The conclusions reached independently by these investigators are practically the same as regards the main features. Their results show: (1.) That the resultant pressure of the wind upon arched surfaces inclined at moderate and small angles of incidence is from two to three times the pressure upon an equal area of flat surface similarly inclined. (The inclination of the arched surface here refers to the inclination of the plane in which the chords of the arch are assumed to lie.) (2.) The action line of this resultant pressure, when the surface is placed at certain favorable angles of incidence, ranging from about 0° to 25° , was found to intersect the chord of the arch at an angle *greater than* 90° , and in such a sense as to produce a *forward propelling component*; that is, if ACB , Fig. 1, is a section of an arched surface by a vertical plane parallel to the lines of flow of the wind across the surface, and PC the resultant wind pressure, then the angle AOP is found to be greater than 90° .

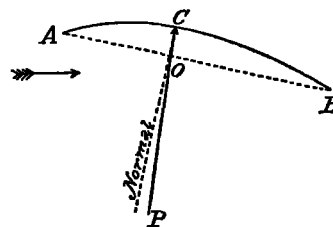

FIG. 1.

The second of these results is of special importance in designing kites intended to attain very great elevations. As yet, however, it can not be admitted that these conclusions are fully established. A. v. Obermayer³ has called attention to a serious source of error in the methods employed by both Lilienthal and Wellner, and has shown that especially the second conclusion cited above is by no means proven. The real effects of the pressure of the wind upon arched surfaces are, in fact, but very imperfectly known at the present time. The writer has reason to believe that much valuable experimental data on the subject has been obtained which is not yet published.

Center of pressure.—The foregoing discussions relate to the *direction of action* of the resultant pressure upon flat and arched surfaces respectively; we will next consider the position of the point through which this resultant pressure acts, namely, the *center of pressure*. Here, again, the general laws of hydrodynamics, so far as known, do not suffice to definitely locate the center of pressure, except, perhaps, in certain simple cases. Its position must, therefore, be sought by means of experimental investigations. Joëssel, Kummer, Langley, Lord Rayleigh, and others have contributed to this question. Joëssel's results were published in 1870. Those of Kummer in 1875 and 1876. The work of Kummer comprises experiments with paper bodies modeled to resemble heavy shot and cannon projectiles. The position of the center of pressure was also determined for square and rectangular planes formed of sheet tin. These, however, he found were bent by the pressure of the wind, thus causing erroneous results, so that afterwards he was led to repeat his observations on plane surfaces, which, for this purpose, were made of thin plates of glass. While his results are strictly applicable only to small bodies (planes 90 by 180 mm. and less) moved at moderate velocities (less than 18 miles per hour), his experiments are quite as comprehensive as any. Langley's investigations are of more limited scope (confined to a plate 1 foot square), but the results, so far as they go, bear internal evidence of high accuracy. Lord Rayleigh,

³Über die Wirkung des Windes auf Schwach gewölbte Flächen. Von A. v. Obermayer. Sitzungsberichte der Kaiserlichen Akademie der Wissenschaften. Heft VIII. Vienna, October, 1895.

from purely theoretical considerations, has deduced a formula, stated below, giving the position of the center of pressure on plane surfaces. There is a remarkable agreement between the theoretical formula of Lord Rayleigh and the experimental results by Langley. If d is the distance from the front, or windward edge of a rectangular plate to the position of the center of pressure, and if l is the length of the plate in the direction of the flow of the air particles across it, and i is the angle of incidence to the wind, then, according to Joëssel:

$$d = l(0.2 + 0.3 \sin i) \quad (1)$$

and, according to Lord Rayleigh:

$$d = l \left(0.5 - \frac{3}{4} \frac{\cos i}{4 + \pi \sin i} \right) \quad (2)$$

The formulæ given above for the position of the center of pressure are strictly applicable only to simple rectangular flat surfaces. Kummer's work conclusively demonstrates that even a slight curvature gives rise to very considerable differences in the position of the center of pressure. It therefore results that the general laws of hydrodynamics, and even the results of any direct experimental investigations thus far known, will be of little or no assistance in correctly locating the position of the center of pressure of the wind upon ordinary kites, because their surfaces, even when of the simplest form, will be so different from those employed in experimentation or considered in theoretical deductions that laws thus determined can not apply.

Much looseness prevails in the use of the term *center of pressure*, and it is very important that a clear idea be formed of its exact mechanical significance. When we think of the pressure of the wind upon an infinitely thin and rigid smooth plane we are dealing with a system of parallel elementary pressures acting at every particle of the surface, and there is then a very close analogy between the center of pressure, that is the point at which the resultant may be conceived to act and the center of gravity, for example. This center, whether of gravity or wind pressure, can, however, have a real existence *only* when the forces are unaffected by angular alterations in the position of the body. This is regarded as true in our ordinary dealings with terrestrial gravitation, but obviously when we deal with wind pressures upon material objects, even of the simplest form (and much less so with the complex devices we call kites), the forces of the system are no longer parallel, and even if they were the slightest modification of the angular relations between the body and the wind would change in a corresponding manner the whole system of forces. Under these circumstances no real mechanical significance can be attached to the so-called center of pressure, except that it is *some* point on the action line of the resultant of the whole system of forces. We may, for example, imagine the center of pressure to be the point where the action line of the resultant intersects the surface of the body, but we may just as logically imagine it to be a point within the interior of the body, or any other point on the line of the resultant. In fact, in the mechanics of the wind pressure upon material objects there is no such thing as the center of pressure. The thing which does, however, have a real existence is a *central axis*. It is a line, not a point, we are to think of in this connection as having some mechanical significance, and when we wish to limit our consideration to some specific point of this *central axis* as the origin of a force its significance is simply that of an assumed point of application of the force.

Summary.—The foregoing analysis of the pressure of the wind upon sustaining surfaces of kites leads us to the following conclusions: (1) The resultant pressure (including skin friction) is sensibly normal to flat surfaces, and under favorable conditions the resultant pressure upon arched surfaces

may possibly be so inclined that a component will act in a direction forward of the normal to the chord of the arch. (2) When the edges of thin rectangular flat surfaces are presented respectively perpendicular to and in the same plane with the direction of the wind then the *central axis* of the system of pressures intersects the surface at a point (center of pressure) which is given with a close degree of approximation by Lord Rayleigh's formula, equation (2) above. For flat surfaces not rectangular in form or presented to the wind otherwise than specified and for the complex and multiple flat and arched surfaces usually found in kites the position of the *central axis* can not be located, *a priori*. (3) The intensity of the pressure upon slightly arched surfaces at small angles of incidence, such as those at which kites are ordinarily flown, is, upon the authority of Hargrave, Lilienthal, and others, considerably greater than upon an equal area of flat surface at the same inclination.

Pressure upon the framework.—The framework of the kite contains a variety of surfaces which are presented to the wind in a great diversity of ways. Some are completely sheltered behind the sustaining surfaces, others are partly, and many, especially in cellular kites, are fully exposed to the wind's action. The general characteristics of wind pressures already enunciated will fully suffice for analyzing in detail the effect of the wind upon the framework. Such an analysis, however, is not now required. Whatever the pressure of the wind may be on the individual surfaces its total effect may be represented by a single line of appropriate length and direction. The point of action of this total effect can not, in general, be exactly located. This, however, is not of special importance, since the whole force is small compared to the main pressures acting upon the sustaining surfaces. Owing to the favorable disposition of a considerable portion of the surfaces of the framework the pressure of the wind thereon will be partly beneficial in character, that is, it will have at least a slight lifting tendency and, as a result the line representing this total effect will have an upward inclination.

Pressures upon edges.—At least portions of the exposed edges of the covering material of kites are subjected to pressures which are not treated of under either of the foregoing topics. These pressures are now considered, and, as in the case of the framework, the whole pressure may be summed up into a total effect, which can be represented by a certain line. The point of action of this total force also can not be located with accuracy, but this is of very slight consequence. Any unbalanced upward or downward pressure upon the edges may be regarded as a pressure belonging properly to those upon the sustaining surfaces themselves, and should be included in the resultant pressure thereon. As a consequence of this the action line of the resultant pressure on the edges will be horizontal.

Pressure upon neutral surfaces.—These surfaces are designed to be neutral under conditions of normal flight and should, therefore, experience only equal pressures upon the opposite sides; the pressure upon the exposed edges belongs properly with the class considered in the preceding paragraph. Owing to imperfections in the kite structure and lack of perfect symmetry of corresponding parts, it will probably never happen that the neutral surfaces are really neutral as regards the equality of pressure upon opposite faces, so that even during steady flight there will be a slight excess of pressure upon one side of such surfaces. The real function of neutral surfaces is to steady the kite during variations in the wind force, and this action will be considered when discussing the stability of the kite under variable winds.

Forces of wind and gravity upon tails.—As ordinarily made the tail consists of long strips of cloth, often with a bushy tassel at the free end. A better form consists of tassel-like bunches of paper or cloth tied together at intervals on a

length of string. Probably the most efficient device for the tail consists of a series of light, hollow, cloth or paper cones, strung together upon a string or wire and presented with their bases to the wind. All such tails are fastened to the kite by a piece of string or equivalent flexible attachment, and they will therefore draw away from the kite in a direction which is the action line of the resultant of all the forces affecting the tail at the kite. The direction of action and the intensity of this resultant force is all that now concerns us in our study of the mechanics of the kite. To fully determine these data experimentally for specific cases, it will suffice to detach from the kite the tail whose constants are desired, and fasten it to a suitable dynamometer, Fig. 2, placed in neutral equilibrium as regards both wind and gravity, and provided with a graduated arc for measuring the angles of deviation from the vertical assumed by the tail when exposed freely to the action

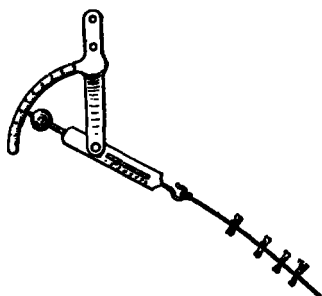

FIG. 2.

of the wind. By this means the resultant force exerted by a given tail in winds of different velocities may be fully established, which data are the constants of that particular tail.

Kites may be provided with other appendages than described above which answer some of the purposes of a tail. These may resemble the tails of birds or have rudder-like effects. Such devices are, in fact, a part of the kite structure itself, being more or less rigidly connected therewith. Appendages of this character are generally very pliable and easily flexed by the pressure of the wind, and their efficacy will often result from vibratory, fluttering motions which they acquire under the action of the wind, and which are discussed in the following paragraph:

Effects of fluttering, waviness, etc.—Throughout the analysis of the action of the wind upon the structure of the kite it has been virtually assumed that all portions are quiescent relative to each other. If the action of the wind causes fluttering and produces a more or less permanent system of waves over the pliable material of which kite surfaces are generally made, or, if the kite structure is provided with special members which are designed to be set in vibration by the wind for the purpose of producing musical sounds, etc., as is the case, for example, in some of the ingenious oriental kites, then whenever such effects are present there will be called into action an additional force, not thus far considered, and which will result from the action of the wind upon the wave fronts, etc. By reason of this action the surface so affected will tend to be pushed along in the direction in which the streams of air flow across it, just as a flag, for example, with its surface formed into a multitude of waves tugs at its halyards with much greater force than if the waves were wholly absent. We may, therefore, represent the effect of waviness and fluttering by a line parallel to the general flow of the air over the kite surfaces.

Whirls, or eddy effects.—There is another circumstance which may produce an effect not thus far considered. In some forms of kites a greater or less portion of the whole current of air affected by the presence of the kite is broken up into numerous whirls, or eddies. These may be formed

when the air flowing against the kite is suddenly stopped, or when its movement is abruptly changed and diverted to a new direction. Angles and changes in the continuity of the surfaces such as formed by the presence of the cross stick in the malay kite, for example, and other causes that prevent the air from flowing easily and by smooth changes of motion over and past the kite will give rise to eddies. Whirls of marked character exist over the leeward surfaces of the kite. Strong eddies may thus be set up at numerous points adjacent to the body or surfaces of the kite. It is possible, and indeed quite probable, that some of these may remain nearly stationary in certain favorable spots. Such eddies, or whirls, in a certain sense, may have much the same effect as obstructions to the flow of the air. Quite as much of an obstruction may be thus formed as if an excrescence of rigid material were placed on the kite at one of the points in question. In cellular kites generally the cells are virtually short tubes through which large streams of air must flow. Pronounced eddy formations within these tubes have much the same effect as real obstructions by which the flow of the air is, as it were, choked up. We perceive, by the aid of the comprehensive principle of the conservation of energy, that the power required to form these eddies and maintain the air within them in rapid motion must be derived by reaction from the kite and its string. The necessary reaction can be derived from the kite only when the resultant forces acting thereon experience some modification, depending upon the presence of the eddies. The nature of this modification must be equivalent to a force which tends to cause the kite to move in the direction of the general current of air. The eddy effect may, therefore, be represented by a horizontal line.

Combination of all wind effects.—We have now separately analyzed the action of the wind upon the several more or less essential members present in all forms of kites. We have also shown the general characteristics of the resulting forces so far as they are of importance in the theory of the kite, and called attention to the effects of waves and eddies. Let us next combine these several elementary effects, and thus ascertain the general total effect due to the action of the wind upon the whole structure of the kite. This total effect of the wind is the force we have designated (1) above.

In assigning a magnitude and direction to any of the several wind effects it is to be observed that the wind is not constant either in force or direction, nor is it even homogeneous. We therefore assume that the value of all those wind effects whose interrelations we wish to study are *momentary values, simultaneously taken*. Furthermore, owing to this momentary character of the forces, the kite is constantly obliged to shift its position in order to adapt itself to the ever changing conditions. At any assigned moment the kite is, therefore, doubtless already in motion as a result of the relations between the forces of a previous condition. Recognizing this circumstance, which is of great importance in the dynamics of the flight of birds and flying machines, but yet of only passing interest in the statics of kites, we assume that, in view of the small mass of the kite, in relation to the large forces acting thereon; a condition of rest promptly ensues whenever equilibrium exists between the forces, and that the movement executed by the kite at an instant when equilibrium does not exist is modified in only an unimportant degree by reason of the momentary velocity the kite may then possess.

The several partial effects of the wind upon the different members of the kite structure, namely: the resultant normal pressure of the wind upon the sustaining surfaces, N ; the total effect of the wind upon the framework, f ; the total pressure effect of the wind upon the edges, e ; the excess of pressure upon one side of neutral surfaces, n ; the total effect due to waves and fluttering, w ; and, finally, any effect due to the presence of eddies or vortex motions, v , can all be combined

in a simple manner by aid of the graphic methods employed in mechanics. These depend upon the following fundamental propositions, namely: *Any system of forces is equivalent in effect and may always be reduced to a single force and a couple, and the force may be made to act through any point.* Also: *When a system of forces has been reduced to a single force and a couple there is but one position of the force possible in which the axis of the couple will be parallel to the direction of the force.* This position of the force is called the *central axis of the system.*

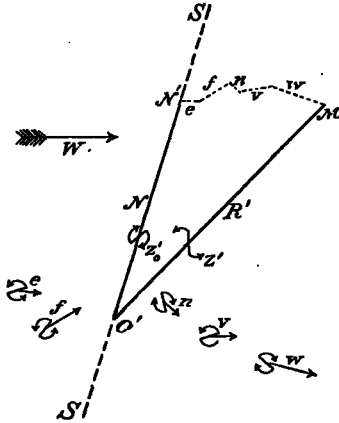

FIG. 3.

Let SS , Fig. 3, be the *central axis* of the system of wind pressures acting upon the sustaining surfaces of any kite. Then by the above cited proposition of mechanics our so-called normal resultant pressure, N , will act in this line. (It may be remarked that if the sustaining surfaces consist of flat surfaces in parallel arrangement then the *central axis* will be sensibly normal thereto, but in general there will be a complex set of surfaces inclined to each other and probably curved; in this case SS , and with it the so-called normal resultant, N , will no longer be normal to the sustaining surfaces; furthermore, N is designated a normal resultant simply because it is the resultant of a system of elementary wind pressures, each sensibly normal to its corresponding elementary surface.) Let C' be the assumed point of application of N . In single surface kites we may take C' where the *central axis* intersects the surface, but in cellular and in other kites we may take some other point. C' may, in any case, be taken at any point on the *central axis* and rigidly connected with the kite. Let $C'N$ represent the magnitude of the resultant, N . It is not to be supposed, as is generally done, that a force like $C'N$ represents the total effect of the wind upon the sustaining surface of the kite. We must also recognize a possible couple Z' , which, in this case, as required by the proposition cited above, acts in a plane perpendicular to $C'N$. (When a force and a couple are in perpendicular planes the couple will be designated with a subscript zero.) The possible existence of a couple of this character is but rarely or never recognized in the discussion of wind pressures upon surfaces, but, as we shall see hereafter, it is a factor of vital importance in the mechanics of a kite. Let the couple be indicated on the drawing by the Z-formed character, thus:

Appended to the action line of the force with which the couple is supposed to be associated. The arrow points indicate the direction the couple turns. As we shall presently find, it is necessary to deal with couples which do not act in a plane perpendicular to the force with which they may be associated, we shall adopt the convention of indicating this fact by modifying the symbol, thus:

In proceeding further to represent in Fig. 3 the remaining partial effects, $e, f, n, v,$ and w , of the wind upon the kite, it

is to be noticed that each one of these effects, for example, the resultant pressure of the wind upon the framework, is the resultant of a complex system of forces and according to our fundamental principle each system is reducible to a single resultant force and a couple in a plane perpendicular to the force. These resultant forces are not necessarily in the same plane as the principal wind pressure, N , nor even parallel to such a plane. Moreover, we can not assign, *a priori*, any fully logical relation between the position and magnitude of any one of these resultants and those of another or the resultant N . But this is not of any consequence, as will be shown. We are, however, able to affirm something as to the *direction* in which the forces act. This was done in a general way when the several effects were separately discussed. Obviously, the tendency of all these effects is to force the kite leeward. The pressures upon the framework, for example, may have a slight supporting component; an excess of pressure upon one side of a fin or neutral surface may push sideways at a high angle, but all the forces *trend to leeward*. If this be not so, then we are confronted with the absurd or impossible consequence that the wind, blowing against a body of assignable form, but uninfluenced by any other forces, as for example is the case if the body is cast free in the wind and has the exact density of the ambient air, is able to cause this body to *move steadily to windward*. "Aspiration," in its essence, is not more nor less than this impossible consequence.

The projected direction of the wind is shown at W and in conformity with the foregoing we have shown, in Fig. 3, the projected positions, chosen at random, of the several partial wind effects, each associated with a couple. We do not affirm that any of these couples necessarily have finite values. We need not say more than that each of the several forces is the result of the action of a complex system of forces applied at innumerable points of the kite structure and the principles of mechanics require that the possible existence of these couples be recognized.

As we have said, the relative magnitude of the forces can not be accurately assigned. Compared with N the others are all small, much smaller than shown, as the lines in the diagram are made longer than logically proper simply for the sake of clearness. The force, N , is by far the largest and most important force acting upon a kite, and each of the other forces may be regarded as a small disturbing influence superposed upon the primary effect N , which is due to the relatively simple pressure of the wind upon the sustaining surfaces. We have thus shown by groups in Fig. 3 all the forces due to the wind that may act upon any kite. The combined effect of these constitute the force we designated (1) in our original category. It will be remembered, too, that other forces were enumerated as acting on the kite, namely, gravity (2) and the pull of the tail (7). We will not at once combine all these forces into a single resultant, as we might do, but we will first combine only those shown in Fig. 3, in order that we may thus ascertain the total effect of the wind, and at the same time be able to show how the several small modifying and disturbing forces and their changes affect the final result.

By the principle of mechanics that any system of forces is reducible to a single force, acting through any point and a couple, we obtain for the system of forces shown in Fig. 3 the single force, R' , acting through C' , and the couple shown at Z' . The single equivalent force is found graphically by means of the well-known principle of the polygon of forces applied as indicated by joining to $C'N$ the broken dotted line made up of parts parallel respectively to the forces, $e, f, n, v,$ and w , thus giving the resultant R' . Thus far we have not affirmed anything of the plane of the diagram, except that it contains the force N , we now assume that it was so chosen as to contain also the resultant R' . It is to be noted,

however, that the other forces are not necessarily in this plane nor parallel to it. The couple, Z' , not only represents the effect of the several original couples, but also includes the couple resulting from the combination of the system of forces, $N, e, f, n, v,$ and w . The full identity of this couple can not be determined *a priori*. We know, however, that its axis need not necessarily be parallel with the resultant R' . The fact that the possible existence of a couple is recognized is sufficient for our present purposes and its whole effect will be taken into account when we come to establish the conditions necessary for equilibrium.

The following analysis brings out the effects of the small forces we have called disturbing influences. Suppose all these forces are so small that they may be neglected, the resultant, R' , will then be sensibly coincident with and equal to N . No one of these partial effects tends to neutralize that of another. All combine to increase the angle included between N and R' . The magnitude of R' will depend, in a secondary and unimportant manner, upon the disturbing forces. The resultant, R' , will be exactly the same as shown, no matter what positions may be chosen for the partial effects, provided their magnitude and direction remain the same. We have shown that the direction of action of all these forces *must trend to leeward*, and whatever finite values and rational directions may be assigned to these forces, it is clearly demonstrated that, by reason of their disturbing influence, *the action line of the total wind effect on any kite is deflected away to leeward from the direction of the resultant pressure upon the sustaining surfaces*. Furthermore, the fact that these several forces can exist in nonparallel planes is sufficient to produce a final resultant couple, and, as we shall see hereafter, the presence of a couple among the forces acting upon a kite may be the source of much mischief.

The complex nature of the forces resulting from the action of the wind upon all the parts of the kite has necessarily involved a corresponding intricate analysis in order to clearly set forth the real character of that action.

Like all systems of forces this system (1), as we have found, is reducible to a force, R' (which in the present case we have arbitrarily chosen shall pass through the point C'), and a couple, Z' . Let us next combine all the forces acting upon the kite, namely, (1), (2), and (7).

Combination of all the forces.—In Fig. 4, let $C' M$ represent the total pressure effect, R' , of the wind upon the entire structure of the kite. (The deviation of the force, R' , in Fig. 3, from the normal resultant force, N , was unduly exaggerated for the sake of clearness in that diagram. The line, R' , in Fig. 4 is given a less pronounced deviation.) Let (2) represent the projected force due to the weight of the kite, acting at its center of gravity, and (7) the force exerted at the kite and due to the influence of wind and gravity upon the tail. The forces (2) and (7) are not necessarily in the same plane as R' . On the average the tail will generally dispose itself in a vertical plane, and the forces (2) and (7) might, therefore, be regarded as in the same vertical plane; but there is no advantage in thus specializing our analysis, and we will, therefore, regard the forces (2) and (7) as in different planes. T and g are the projected positions of the points of attachment of the tail and the center of gravity, respectively.

All the *independent* forces that in general may act upon any kite are now fully recognized and represented in the diagram, Fig. 4. The restraining pull of the line, as already pointed out, is not an independent force, but exists as a result of the combined action of the other forces. This pull of the kite line is the force that is to put the whole system of forces in equilibrium.

The combined effect of the forces, $R', (2),$ and (7) , may, as we have seen, be reduced to the single force, R (obtained by aid of the polygon of forces, as indicated), and a couple, which

we will designate by Z'' . Let the two couples, Z' and Z'' , be compounded by the methods of mechanics into the single resultant couple, Z , which will be omitted from the diagram to avoid confusion of lines. In Fig. 4 the plane of the diagram is so chosen as to contain both forces, R' and R .

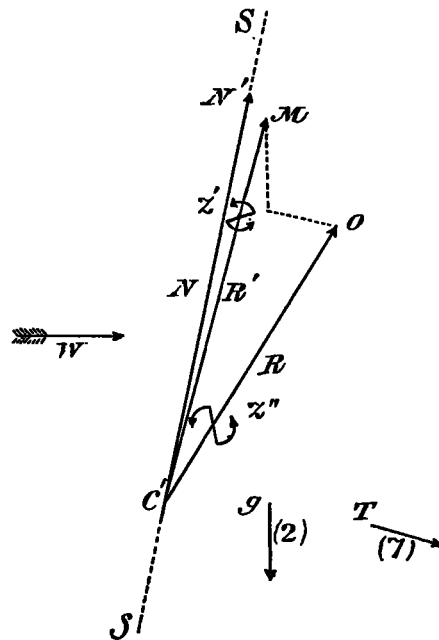

FIG. 4.

This force, R , and the couple, Z , are the final desiderata in our analysis of the action of the forces upon kites. We have aimed to include in the derivation of this result every possible force that can in any way affect the position assumed by a kite in the wind. The direction of action of the force R is the direction in which the kite will tend to move under the combined influence of all the forces. The function of the force R is to restrain the kite and prevent this motion. The magnitude of the force R is the measure of the force with which the kite will "pull." The relation which R bears to the elementary and partial effects of the wind, viz, the partial effects, $N, e, f, n, v, w,$ and the important forces, (2) and (7), has been fully shown in connection with the diagrams, Figs. 3 and 4. Z is a couple which tends to turn the kite about an axis not yet determined, but not necessarily parallel to R .

Having thus fully established, in the most general manner, the character of the combined effect of all the independent forces acting upon any kite, we will proceed at once to indicate the conditions that must be satisfied in order to produce equilibrium.

V.—CIRCUMSTANCES OF EQUILIBRIUM AND MOTION.

The problem presented for present consideration is: Given the force R and the couple Z , which represent the combined and total effect of all the forces due to wind and gravity that may act upon any kite, to find how the string or kite line shall be attached in order to produce equilibrium and to explain the various movements of a kite.

Let $C' O$, Fig. 5, represent the resultant force R as found in Fig. 4. Also, let Z represent the couple resulting from the combination of Z' and Z'' .

We have added to the diagram a pictorial representation of a common form of kite, in order to assist the mind in grasping the general relations we seek to establish, but this can not in any way limit or confine our conclusions to that specific form of kite, for the whole analysis of the forces has, from the first, been conducted upon the most general lines possible, and the conclusions apply equally to all kites.

The point C' , it will be remembered, is the point of application of the resultant normal wind pressure upon the *sustaining surfaces*. It is intended to show the point, C' , displaced slightly from a perfectly symmetrical position with respect to the figure of the kite. The reason for this choice is that in all kites unavoidable defects of construction and inequality of effects will cause the position of C' to be more or less eccentric.

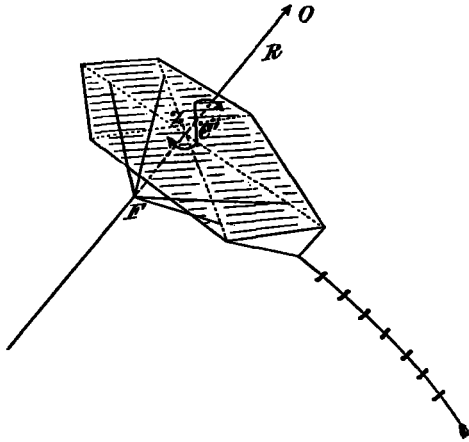

FIG. 5.

If now we assume that the couple $Z=0$, it is plain that the entire effect of wind and gravity on the kite and its tail is represented by the single force R , and obviously all that is necessary in order to hold the kite in equilibrium is that the string shall be so fastened to the kite that its action line (that is, the string prolonged) shall be able to coincide with R . This is the condition shown in Fig. 5, and the point C' , it will be remembered, is the point where the *central axis* of the system of *sustaining pressures* intersects the kite. It is also the point at which the *central axis* for the *entire system*, including every force, intersects the kite. We thus recognize that $Z=0$ affords a special case of possible equilibrium, yet, owing to the necessarily rare occurrence of such a condition, we give it no further notice.

Equilibrium when Z is finite.—Equilibrium is possible, but with some limitations, when Z is finite, and provided further that its axis is not parallel to R . In Fig. 6 let the axis of the couple be inclined to the direction of R . By the methods

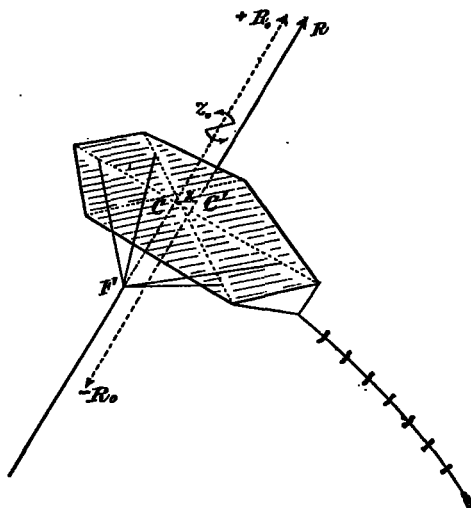

FIG. 6.

of mechanics this couple can be resolved into two component couples, one having its axis parallel and the other perpendicular to R . Let the parallel component be designated Z_0 ,

and the other one P . The forces of the latter couple will be in a plane parallel to R . Now transform the couple P into one whose forces $+R_0$ and $-R_0$ are each equal to R . The arm of the couple will then be $x=P \div R$. Move the couple parallel to its plane and turn it about its axis until one of its forces, $-R_0$, is directly opposite to R . These forces thus neutralize each other, and the whole system of forces has thus been reduced to the couple Z_0 and the single force R_0 , parallel and equal to R , and acting in the same direction but at a perpendicular distance, $x=P \div R$, from it. The action line of R_0 now coincides with the *central axis* of the *whole system of forces*, including gravity and the tail. The string can now hold the kite in equilibrium only when $Z_0=0$, and when the bridle or other device for fastening the string is so arranged that the action line of the latter can coincide with R_0 . These are the general conditions of equilibrium. The point C , at which this action line of the force R_0 cuts the surface, is often said to be a center of pressure, but had we chanced to show in our picture a Hargrave kite, for example, all our conclusions would hold just the same, and it is possible that the action line of the force R_0 might then have failed to intersect any of the actual surfaces. A center of pressure which has specific, definite, and assignable properties can not exist in the present connection, and we believe that on account of the obscure and indefinable conception of center of pressure generally entertained by experimentalists, investigations upon the position of the so-called center of pressure, and especially measurements of the pressure of the wind upon arched surfaces, have often led to erroneous and even anomalous conclusions.

In the preceding pages we have given an exhaustive and classified analysis of both the principal and the subordinate or modifying forces which act upon any kite. We have endeavored to show the general character and relative importance of the complex effects resulting from the action of the wind upon the whole structure exposed to it. Finally, all the forces have been combined and the general conditions of equilibrium established, as explained in connection with Fig. 6. Our final conclusions are not, however, dependent upon this elaborate analysis of the action of the forces, nor are they affected in any way by faulty or questionable assumptions therein unavoidably made. It is obvious, moreover, that the presence or the absence of any one or all of the several disturbing wind effects we have considered is not necessary to the final results. Any one or all may be infinitesimal and the resultant R' and Z' , Fig. 3, may be determined for the forces that remain, just the same. So again, the presence of the tail is not essential. The force (7) may be made zero in Fig. 4 and the tail vanishes from the mechanics of the problem. The resultant R of the remaining forces is found just the same however. The very general character of the foregoing theory of the kite is thus exhibited.

We have said that the forces which we designated e , f , n , v , and w , were in the nature of disturbing influences that modify the results which would ensue if we had to deal only with the main pressure of the wind N upon the sustaining surfaces. It is also apparent that the effects of the weight (2) and of the tail (7), as shown in Fig. 4, are closely analogous in character to those of the above mentioned disturbing effects. The force (2) in a very direct manner tends to diminish the magnitude of the resultant R , while the presence of the force (7) causes an angular deviation of the resultant R away from R' and N and in a leeward direction. In general, it is desired that what we may call the *upward going tendency* of a kite shall be the greatest possible, while the tendency to go to leeward shall be the least possible; that is, that the *lift* shall be a maximum and the *drift* a minimum. Now with the sustaining surfaces of our kite set in a particular attitude to the wind we get a force N having a certain *lift* and *drift*, whereas, owing to the

presence of numerous disturbing effects, due to the action of the wind on the framework, etc., and these further aggravated by the effects of the weight (2) and the tail (7), we are able to realize out of this original and primary force N , only a modified resultant force R , which has a *less lift* and a *greater drift* than N . The kite is, therefore, by reason of the presence of these disturbing forces, including the weight and the tail, less effective than it would be if there were nothing present but sustaining surface. In the *ideal kite* we imagine all these disturbing causes absent. Such a kite is one, therefore, without weight or tail, and which is made up wholly of *sustaining surfaces*.

Finally, the general conditions of equilibrium developed in the foregoing analysis are identical with those which, at the beginning of this paper, were shown to necessarily follow as the result of the fundamental principles of mechanics.

VI.—EXPLANATION OF THE FLIGHT OF KITES.

In general, kites are restrained by only a single line fastened either to some form of bridle or directly to some point of the framework. More lines than one are, however, sometimes used, as, for example, in the case of dirigible kites. With two independent flying lines, either of which may be paid out or wound in at will, an operator is able to control, within certain limits, the position of his kite in either altitude or azimuth. With three independent strings fastened to the kite at points not in the same line, the operator may cause the kite to ascend or descend as well as fly to the right or the left of the lee point. Such systems of lines are simply equivalent to the well-known bifilar or trifilar suspensions. At a given instant of time, with lines of fixed length and for a certain position of the kite, the forces acting in the several strings are always equivalent to a possible couple and a single force which acts through a determinate point and in a definite direction, which will be parallel to the axis of the couple. If two strings are used the determinate point will be in the line joining the points at which the strings are fastened to the kite or its bridles. With three strings the equivalent force will pass through a determinate point located in the plane containing the three points at which the strings are made fast to the kite. If more than three strings are used the separate forces in them will be indeterminate in relation to the force R_0 , but their resultant, when equilibrium prevails, must be in line with and opposed to R_0 .

The use of more than one line becomes impracticable in many cases and limits the flight of a kite to moderate elevations.

The explanation of the phenomena of flight given below proceeds upon the assumption that the kite is held in restraint by a single line only. On page 147 will be found some further reference to effects resulting from the use of two or more strings.

Let the reader imagine any kite he pleases launched into the ever-changing wind under the restraint of one string, its behavior is developed in detail as follows:

At each instant, and in each position, the whole effect of the wind and gravity is reducible to a single force R_0 and a couple Z_0 , whose forces act in a plane perpendicular to R_0 . The kite at first will probably not be in equilibrium because Z_0 is probably finite, but more particularly because the manner of attaching the string to the kite so limits and restricts the possible relations these two may assume that coincidence between the action line of the string and that of the force, R_0 , is impossible. Let the condition of affairs at a given instant be as shown graphically in Fig. 7. R_0 , assumed to act at C , is the equivalent force; Z_0 the resultant couple of the system; F is a point through which the string constantly pulls. The bridle shown in the diagram makes the point F , bear a fixed relation to the kite, yet that circumstance does not limit

our conclusions. In whatever manner the string is fastened to the kite, F is to be regarded as simply a point through which the action line of the string always passes, and it may be either fixed in relation to the kite structure, as in the illustration, or it may be capable of moving in some prescribed manner in relation thereto. When a bridle is made of a single bight of string, as in malay kites and those of other forms, the point F is not fixed but is constrained to a circular arc in a plane perpendicular to the midrib.

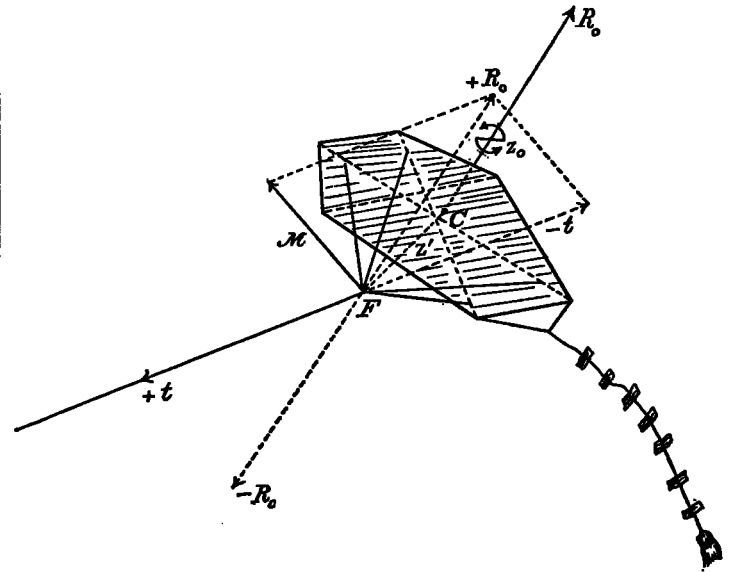

FIG. 7.

Without affecting the system of forces in any way we may apply at F the two equal and opposite forces, $+R_0$ and $-R_0$, each equal and parallel to R_0 at C . The whole system now consists of the "pull," or tension of the line, and the force $+R_0$, both acting at F , also two couples, namely: Z_0 and the couple Z' , consisting of $-R_0$ at F and R_0 at C . The movements it is possible for the point, F , to execute are limited and are constrained by the string to be in a surface, the origin of which is at the fixed end of the string and the radius vector of a point the catenary formed by the string. If the length and curvature of the string are invariable the surface of constraint will be spherical. To find how the point F will move, we resolve the force $+R_0$ at F into two components, one, $-t$, acting in a direction along the string, the other, M , tangent to the above-described surface of constraint, and in the plane containing the string, and the force, FR_0 . M , then represents the moving force and shows the direction in which the kite will be moved as a whole; $-t$, is a measure of the pull on the line.

The force R_0 , acting at F , has, it will be remembered, been replaced by the two equivalent forces M and $-t$. This latter force calls into existence the tension in the string, that is, our force, (3). The dependent character of this force (3) is thus shown. The tension in the line, t , and the force, $-t$, being equal and opposite, neutralize each other, and therefore, may be dropped from the system. There remain, then, the force M , acting at F , and the two couples, Z' and Z_0 . Let the latter be combined into a single equivalent couple, Z . In order to understand clearly the effects of the couple Z , we shall find it best to differentiate the kinds of angular movements the kite can execute. For this purpose let us imagine the point F , and the string near the kite to be stationary. Three distinct kinds of movements still remain possible to the kite. For example, it may rotate about an axis passing through F , and parallel to the force, R_0 . Secondly, it may tip longitudinally, that is, in a fore and aft sense, about the point F . This motion corresponds to the "pitch" of a vessel

amid waves. Finally, the kite may rock sidewise, that is, careen or tilt laterally, either about the point, F , or about the line joining the fixed extremities of the bridle in case the kite is bridled like a malay kite, for example. This rocking movement corresponds to the "roll" of a vessel.

The axes of the two couples Z_0 and Z' are already perpendicular to each other, hence the one couple can not have any component in a direction parallel to the other, and it will be most convenient to consider the effects of these two couples separately rather than to discuss the action of the equivalent single couple, Z , as a whole. The axis of the couple Z_0 is, it will be remembered, parallel to the force R_0 . Let this axis be moved parallel to itself until it passes through the point F . In this case the axis will coincide with the line $R_0 F - R_0$, Fig. 7. Now the couple Z_0 will make the kite turn its head either to the one side or the other about this line as an axis. At the same time the couple Z' will impart to the kite a movement which in general will consist of both a tip, in the fore and aft sense, and a certain amount of careen or tilt to one side.

It is very important to notice, however, that the movement of the kite, under the action of the couple Z' , tends to bring the point C and the force R_0 , acting through C , directly in line with the point F . As soon as this occurs the whole couple Z' vanishes from the system; that is to say, its moment arm is zero. The kite will, therefore, tip and careen only a limited amount, and thus assume an attitude to the wind in which the action line of the force R_0 passes through the point F .

It is equally important to notice that no matter how the kite may tip or teeter about the point F , this in itself can have no power to suppress or nullify the turning action of the couple Z_0 . The manner in which the action of this couple is controlled will be discussed more fully hereafter.

As a result of the foregoing resolution of the forces acting upon a kite at a given instant of time, the following general theorem is demonstrated. *When the system of forces acting upon a kite is not in equilibrium and is reduced to a single force, M , acting at the point F (the top end of the string), and the couple Z , then the force M will move the kite in a determinate direction tangent to a definite surface of constraint, and under the action of the couple Z the kite will, in general, turn its head to the right or left, will careen laterally to some extent, and tip longitudinally.*

When, therefore, any conceivable form of kite is cast free in the wind and is not in equilibrium under the restraint of its string, incipient motion of the kind defined in the above theorem will ensue. At each moment and at each point of its path, however, the kite is subjected to a new set of forces which differ from the forces of the preceding moment, not only because the wind may have changed, but also because the movement of the kite itself has placed it in a new attitude with respect to the wind, in which new position the forces are correspondingly different, even if the wind be constant. As the kite moves forward and rotates under the action of the couple Z it will, in general, unless it be a very poor kite, promptly assume an attitude in its path such that the couple Z becomes zero and continues sensibly so; that is, its values, when finite, succeed each other rapidly with alternate + and - signs, which means that the kite will execute partial turning movements in opposite directions, and these are often perceptible as rocking, wiggling, tipping, pendulous motions. Moving along its path in this manner the kite presently attains what we will call its *steady position*, which may be defined to be a position in which M has also become zero, or, more exactly, a position in which the values of M are small and rapidly succeed each other in widely diverse directions, while the values of the couple Z_0 , if finite, change signs rapidly. The kite does not, therefore, move far in any one direction, but is con-

stantly shifting its position as a result of its efforts to adapt its position to the changing conditions of the wind. In its *steady position* the relation of forces shown in Fig. 6 is approximately established and we are to imagine that the point C at which the action line of the string chances to intersect the surface of the kite, and which is often thought of as a "center of pressure," is constantly shifting from point to point within a limited space in definite correspondence with the movements of the kite and the changes of the wind. In the meantime the couple of the system takes on constantly changing values, but with quickly alternating algebraic signs, which means that the kite rocks and teeters on its bridle strings, turning its head to the right and left as circumstances may require. Such is the progress of a well-arranged kite from a starting point to its steady position, and such are the actions going on in that *steady position* which will become one of *perfect equilibrium* when the wind is perfectly constant in force and direction, provided further that $Z_0 = 0$.

A well-arranged kite is able to glide gracefully up to its steady position simply because, owing to its symmetry and the corresponding equality of the pressures upon the lateral halves of the kite, the force M falls approximately in a vertical plane parallel to the wind direction, to which plane motion of translation must also be confined.

The application of the general propositions of mechanics is sufficient to thus explain every phase of the movements any kite may execute, nor does the theory make any distinction between kites that are good and those that are bad. Any object blown by the wind and restrained by a string is a kite within its meaning, and the darting and gyration, the diving and spinning, the downward as well as the upward or sagging flight a kite may execute when flown from a point well up in the free air—all its evolutions are equally explained and accounted for by the relations that are possible between the force M and the couple Z .

A study of the conditions that contribute to the stability and steadiness of a kite is a most important application of its mechanical theory. Before entering upon such a discussion, however, we will first trace out the conditions and causes of the more characteristic evolutions of flight, and thus be the better able to understand how the flight may be controlled.

VII.—ABNORMAL FLIGHT OF KITES.

Assuming the flow of the wind to be in straight lines and steady, we may regard normal flight to obtain when the kite assumes and holds a steady position which is dead to leeward, that is, when the kite and the string are in a vertical plane parallel to the direction of the wind. Normal flight in a steady position results when the force R_0 is in the vertical plane of the wind and $Z_0 = 0$.

One of the primary and ultimate causes of abnormalities in kite behavior is to be found in the general and fundamental weakness of kite structures. The idea is popularly current that yielding, flexible construction is of great advantage. There is little or nothing in mechanics to support such a claim, and there is much against it. Elastic bending and yielding of a framework is much more likely to take place *unsymmetrically* than otherwise, and distortion of the prescribed figure of a kite is fatal to normal flight. Many of those sudden, unexpected, and unaccounted for evolutions of kites that sometimes occur result wholly from distortions made possible by too frail a construction. When the conditions that are essential to stability have been observed and are *rigidly preserved* in a given structure it will fly steadily enough in all winds its strength is capable of resisting.

Suerve, deviate, sag, are terms we may use to designate certain mild kinds of anomalous flight in which the kite tends

to steadily and continuously fly off to the right or left of the direct lee point. This behavior is, to a moderate degree, characteristic of all kites, and is not of serious consequence unless the tendency is greatly exaggerated and the kite flies far off to one side with a downward tendency, in which case the kite is said by some to "sag."

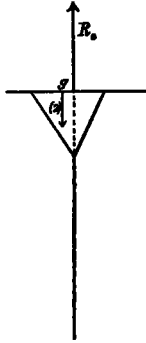

FIG. 8.

These actions all result from the same general conditions which are primarily a want of symmetry. Let us imagine we have a perfectly normal kite and that its steady position is dead to leeward. Let Fig. 8 represent the kite as seen from a point in front (to windward) and in the plane of the kite. In normal flight the string and the force R_0 will be in a vertical plane and appear as shown. Now suppose that instead of being perfect, some irregularity, of density for example, causes the center of gravity to be laterally eccentric, as at g . All the wind forces on the kite must remain exactly as they were before, since a change of density in a portion of the kite can not affect them. The resultant of all the forces, excepting gravity, will still be represented in the figure by a line in the direction of R_0 . Let the force (2) at g now represent the gravity of the kite. This force combined with the force acting along R_0 will give rise to a couple and a resultant, still acting, as it appears projected on the drawing, along the direction of R_0 . The couple will turn the kite, thus changing its attitude with respect to the wind and introduce a whole new system of forces leading finally to a new steady position for the kite, which can not possibly be in the vertical plane of the wind.

By similar reasoning it can be shown that a lateral shifting of the point F , or a change in the point of action of the tail, or a lateral displacement of the point of application, C , of the resultant, R_0 , will cause the kite to fly to one side or the other of the normal plane. The converse of this is also demonstrated, namely, that if a kite flies, moderately at least, to one side of the lee point, it can be made to execute normal flight by a proper alteration of the position of the center of gravity, or a lateral shifting of the point F , if the bridle is of the rigid type, or by a lateral displacement of the action line of the tail, if the kite has a tail. It does not necessarily follow that bad cases of deviation can always be corrected in this manner.

Sagging generally results from pronounced distortion of the prescribed figure of the kite when subjected to considerable strain from the wind, or from original unsymmetrical construction and possible shifting of the loosely-fitted cover. The defect may not always be apparent or discoverable when the kite is hauled in.

Darting, diving, gyrating, spinning, are other terms that may be used to describe evolutions of the kite. These differ from each other in the main only in degree.

Darting will be considered as referring to erratic and approximately periodic shiftings of the kite from side to side, but without losing elevation; a *dart* becomes a *dive* when the kite pursues a downward course for a time, but recovers and

ascends without executing a complete *gyration*. *Spinning* is suggestive enough of the pin-wheel evolutions a kite may execute while standing pretty steadily in one position.

When the resultant force, R_0 , of the system and the action line of the string are sensibly in the relation that corresponds to equilibrium, as shown in Fig. 6, there will be little or no tendency for the kite to move. If now, however, the couple Z_0 has a finite value the kite will turn about an axis sensibly coincident with the string. This turning alters the attitude of the kite surfaces to the wind and results in a change of position. If slight motion of this sort does not cause the couple Z_0 to change its value the movements of turning and translation will, of course, go on. Now *darting* results when a considerable movement of translation must take place before the couple has vanished, but it so happens that at the point in the path of the kite at which the couple Z_0 vanishes the moving force M has a finite value, and the motion of translation continues without any rotation for a short time. A new value of Z_0 with opposite sign and a different attitude of the kite with respect to the wind, however, soon results and causes the kite to retrace its previous movements in a similar but opposite attitude. Thus is produced the continuous periodic movement we call *darting*. M and Z_0 in this case are never *simultaneously* inappreciable, which is the condition for steadiness.

A *dive* is the result of nearly the same condition of forces as a *dart*, except that at the turning point, M and Z_0 , are nearly simultaneously zero. Dives often result from the sudden overthrow of equilibrium due to peculiar inequalities of the wind and temporary distortions of the figure of the kite. The *dive* becomes a *gyration* simply because the algebraic sign of Z_0 does not change throughout the entire evolution; if the kite does not attain the conditions corresponding to a steady position at one *gyration*, it follows that Z_0 is still finite and has the same algebraic sign and that further gyrations are inevitable. The radius of the gyratory orbit is wholly dependent upon the relation between the speed of rotation produced by the couple Z_0 and the velocity of translation under the force M . When M produces a considerable translation during the time that Z_0 turns the kite but a little, then the orbit of *gyration* will be one of great diameter. When the power of the couple to turn the kite is great the orbit of *gyration* will be small. In the special case of $M = 0$ *gyration* obviously reduces to the evolution we call *spinning*, in which M is sensibly zero, while Z_0 is considerable in magnitude and constant in algebraic sign.

Thus is fully explained, from the mechanical point of view, every conceivable movement that any kite restrained by a single line can execute, for any evolution must in character be within the movements classified and explained above.

Our discussion has throughout been a study of the action of certain specified forces, and the reader may use his own choice as to what particular kind of kite he conceives to be the origin of the forces in question. When the conditions among the forces we have specified exist, the evolutions we have described will be executed.

Use of two or more lines.—Very little need be added to the foregoing general explanation of the flight of kites to adapt it completely to the case of kites held in restraint by more than one string.

The three degrees of freedom of angular movement possible to a kite restrained by a single string were fully explained on page 145. Two strings attached at points either side of a fore and aft middle line prevent all sidewise tilting or careening of the kite, and hence only two degrees of freedom of angular motion remain, that is, the kite may still tip longitudinally and may rotate under the action of the couple Z_0 . Even this latter freedom, however, is under some constraint, due to the fact that the system of parallel strings will resist

being twisted up to a certain point; that is, any tendency of the kite to turn in its own plane, or one sensibly agreeing therewith, will be opposed by a greater and greater resistance until the two strings become crossed, whereupon their efficacy to nullify the couple Z_0 practically vanishes. If a kite with two or more strings succeeds in executing one or two complete gyrations the strings will be twisted around each other, and much, if not all the efficacy of the system vanishes until the strings can be untwisted.

We have found that two flying lines not only may serve to suppress and prevent all lateral tilting of the kite surfaces, and place such movements under the control of an operator, but the strings also exert an opposition to free rotation of the kite under the action of the couple Z_0 . This counter-couple action of the strings is not of sufficient power, in general, to completely nullify the couple Z_0 under all circumstances, but it is important to notice that it can contribute to this effect. With two strings the kite will, for these reasons, be more steady in its motions than with one.

We pointed out, on page 146, that in its *steady position* a kite must constantly vary its position and attitude with changes of the wind, and that a so-called "center of pressure," C , constantly shifts from point to point within the surface of the kite. Now, when two strings are used, as shown in Fig. 9, it is obvious that the action line of the resultant force, R_0 , may take many different positions and still constantly pass through the line, $F' F'$, connecting the extremities of the two strings. All these changes of R_0 (and of the point C) can occur without any change whatever in the position of the kite, provided the *direction* of the force, R_0 , remains *unchanged*. Changes within these limitations may often occur, and therein lies another reason why a kite with two strings will fly more steadily than with one.

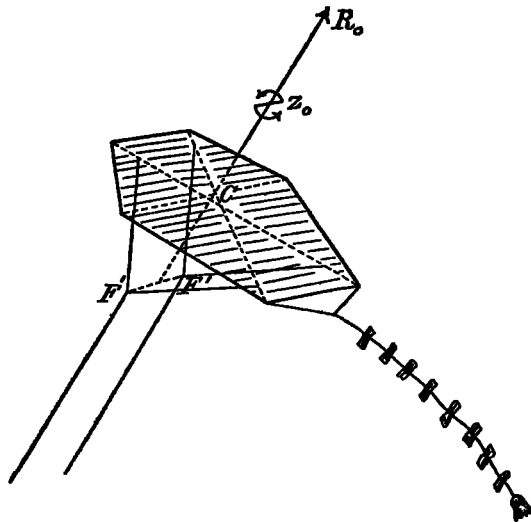

FIG. 9.

When three or more strings are employed only one degree of freedom of angular motion remains to the kite, namely, it may turn its head to one side or the other under the action of the couple Z_0 , but even this, as already explained, is under some constraint from the strings. Furthermore, the action line of the resultant, R_0 , may now take any position whatever, provided that it always passes within the figure which incloses the system of strings, and the kite will be under no necessity of changing its position, except in those cases and only to the extent that the force, R_0 , changes its direction.

We thus see that the use of two or more strings properly applied renders changes in the position of a kite far less extensive than they are likely to be with a single string. While the greatest possible degree of *stability* is thus obtained, yet the *steadiness* with which the kite flies will depend, as always,

upon the control that is exercised upon the couple Z_0 . No matter how *stable* the equilibrium may be, if the couple Z_0 can acquire appreciable finite values the kite is likely to fly in a restless, unsteady manner. For the distinction between the words "stability" and "steadiness," as here used, consult page 153.

The efficacy of dual or triple strings depends wholly upon their not crossing each other. With long, deeply sagging strings necessarily under different degrees of tension it becomes impracticable to prevent crossing, and their use is feasible only in special cases and under considerable tension.

VIII.—EFFECTS OF CHANGES IN WIND AND POSITION OF KITE.

In order to discuss completely the conditions which can contribute to the equilibrium of a kite, it is necessary to understand thoroughly the character of the changes which take place in the systems of applied forces when the kite changes its position or when variations arise in the force or direction of the wind. In this study we must consider both the force, R_0 , and the couple, Z_0 .

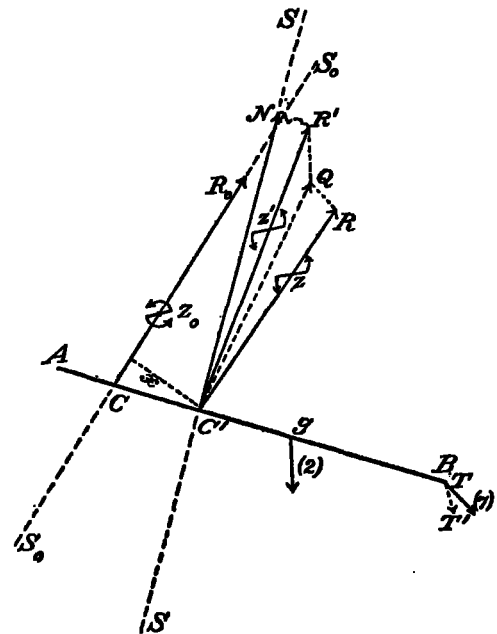

FIG. 10.

Relation of forces.—The relations which the force R_0 bears to the primary forces of wind, gravity, and action of the tail have been fully set forth on pages 142-144. These may be briefly shown again, as follows: If $S S$, Fig. 10, is the *central axis* of that important system of forces due to the pressure of the wind upon the *sustaining surfaces* of any kite and C' an assumed point of application of the equivalent force, N , of the system, then the total pressure of the wind upon the entire kite structure, excluding the tail, will be equivalent to and may be represented by a force R' and a couple Z' , as shown; the former acting through C' , but inclined to N at a slight angle. Again, the total effect of all the forces of wind, gravity, and tail will be equivalent to a couple Z and a single force represented by the line R , also acting through C' . Finally, by resolving the couple Z into components with axes respectively parallel and perpendicular to the force R , and then combining the perpendicular component with R , we get the force R_0 parallel and equal to R , but at a greater or less distance from it. We also get the couple Z_0 , whose forces act in a plane perpendicular to R_0 . These resultants represent the total effect of all the forces acting upon the kite. The force R_0 coincides with the *central axis*, $S_0 S_0$, of the whole system of forces. It is possible, but exceedingly improbable, that in actual kites the forces N , R , Z , and R_0 may all fall

within one and the same plane. We will consider, however, only the more general case, that the forces are in different planes.

To assist in the further study of the results of changes in the forces, we have added to the diagram the line AB and the forces (2) and (7) of gravity and the tail, respectively. The line AB represents simply an edge view of a reference plane parallel, for example, to the longitudinal axis of the kite. It may also be imagined to represent an edge view from the side of a single flat-surface kite. The diagram is, however, representative of any kind of kite if we regard AB as simply a reference plane. The point C' , the center of gravity, g , and the point of attachment, T , of the tail are, for simplicity, all supposed to fall within this plane, but this is not essential. If A is the forward portion of the kite, then C will be nearer A than g ; at least, this is a more favorable relation than otherwise for the most satisfactory flight, as will more fully appear hereafter.

Having thus before us a clear picture of the relations between R_0 and the forces of wind and gravity, we may formulate the changes in R_0 corresponding to variations of the wind and alterations in the position of the kite, as follows:

Variations of wind force.—Mere changes in the force of the wind will have little other effect than simply to alter the magnitude of the force N without changing either the position or the direction of the central axis SS . Furthermore, the force R' will experience a proportionate change of magnitude, but without any important change in direction. These results will follow moderate changes in mere wind force, because, from what is known of the laws of wind pressure, its effects upon the surfaces of the kite, the framework, edges, etc., and even the effects of waves and eddies, are, for slight changes, all proportional to the same power of the wind velocity. For considerable changes of velocity the eddy and wave effects may possibly vary at a higher power of the velocity than simple pressure effects, and if pronounced waves and eddies are present in a given kite, then the direction of the force R' will probably deviate from the direction of N by greater and greater amounts with higher and higher velocities. Such kites are actually blown down and fly lower with very strong winds.

The force (7) due to the tail is partly a wind effect, and for an increase of velocity (7) will be both increased in magnitude and its direction made more nearly horizontal, and *vice versa*.

The weight of the kite (2) is constant, and obviously it follows from the above that even if the force R' changes only in magnitude with variations of wind force, the total resultant R will, in general, take a more horizontal direction and diminish in magnitude with a falling off in wind force, whereas, with increased wind velocity, the resultant R will be greater in magnitude and deviate less from R' .

R_0 is always equal and parallel to R , but the distance, x , between them depends upon the couple Z . We will refer to the variations of x presently.

Variations of the couple Z .—It will be remembered that the couple Z is the total resultant couple of the whole system of forces when that system is reduced to the force R acting through C' . The existence of this couple results principally from the action of the forces of gravity (2) and of the tail (7), but there is also included in Z a small and very important couple effect, resulting from the action of all the wind forces. These form such a complex system of elementary pressures, acting at every conceivable point of the kite, that it is utterly impracticable to produce that exact condition of symmetry required in order that the resultant couple of so complex a system shall necessarily be zero. Or, rather this is only possible by the introduction of certain forces which automatically control the values of Z_0 . While this small couple effect

is included in Z , yet all the variations of Z that are of importance from the present standpoint depend upon the moments of the forces (2) and (7) about the point, C' , which, as we have found above, is not changed in position by a mere change of wind force, *per se*. It follows from this latter circumstance and the constant magnitude of (2) that the moment of the force of gravity remains constant under changes of wind force as long as the kite holds its position. The couple Z will, therefore, also be sensibly constant, provided the kite has no tail. With a tail, the important variations of the couple Z result from changes in the action of the tail corresponding to changes in the force of the wind. Methods of determining, once for all, the magnitude and direction of action of the tail force (7) were fully described at page 141. If the action of gravity on the tail is very small as compared with the wind effects, then the changes of the force (7) will be mostly changes in magnitude, the direction of action of the tail remaining nearly constant and nearly horizontal, except for the very lightest winds. If, however, the weight of the tail is relatively considerable, then the direction of action of the force (7) will change considerably with different intensities of the wind.

It results from the foregoing that the values of the couple Z , corresponding to the possible values of the tail force (7), may vary considerably with mere changes of wind force; thus, when the action line of (7) passes through C' the moment is zero; if the tail blows out horizontally the action line in general will pass below C' , and the moment will then have the opposite algebraic sign from the moment due to gravity acting at g ; while with the tail in the position shown in the figure, its moment and that of gravity have the same sign. We, therefore, see that, in general, even slight changes in the wind force alone can give rise to considerable and important changes in the couple Z .

We are now prepared to consider further how changes in the couple Z affect the force R_0 . When Z is resolved into two components, Z_0 and Z_1 , of which the latter is combined with the force R , in the manner already explained on page 144, we get the force R_0 , the position of which will be forward of R ; that is, nearer the A end of the kite than R . This is necessary because the moment of R_0 about an axis through the point C' , perpendicular to R , must be equivalent to the couple Z_1 . The perpendicular distance, x , between R_0 and R must, moreover, be $x = Z_1 \div R$. Even supposing now that Z remains constant under variations of wind force (and this can be the case with the tailless kites) it is obvious that x varies inversely with R . When Z is not approximately constant its values, in general, will tend to increase, rather than otherwise, with diminution of wind force, because the force (7) then takes a more nearly vertical direction, as shown at $T T'$, tending, on account of the rapid increase of leverage, to produce a greater moment about the point C than before. The combination of circumstances that can cause the couple, Z to diminish when the wind force diminishes is an improbable and therefore not an important or general combination for our present purposes. From the foregoing it results that, in general, when the wind force diminishes, not only does the resultant R_0 diminish in magnitude and change the inclination of its action line, but the whole axis, $S_0 S_0$, shifts to a new position nearer the forward end of the kite.

To avoid confusion the distance x is greatly exaggerated in the figure. R_0 , in general, is a very large force compared with (2) and (7), and as a result the numerical value of x and its variations will be small, except in very light winds.

It must be noticed that thus far we have considered only the changes that take place instantly in the relations between the forces whenever the force of the wind changes. The kite itself it still supposed to retain its original position.

Résumé of results.—Briefly stated, what happens among the

forces acting upon a kite when the wind pressure changes is this: (1) The pressure N upon the sustaining surfaces simply changes magnitude, but retains sensibly its original action line and position; (2) The total resultant R_0 , not only changes in magnitude directly with the wind force, but when the wind force diminishes its direction deviates more from the vertical and its position shifts toward the forward end of the kite, and *vice versa*. Finally, the couple Z_0 , which is sensibly zero when equilibrium prevails, in general will not necessarily undergo any important change. The couple may take on a small value which may be either positive or negative, or it may remain zero. Any one of these results may occur in special cases, and even in the same kite under diverse circumstances.

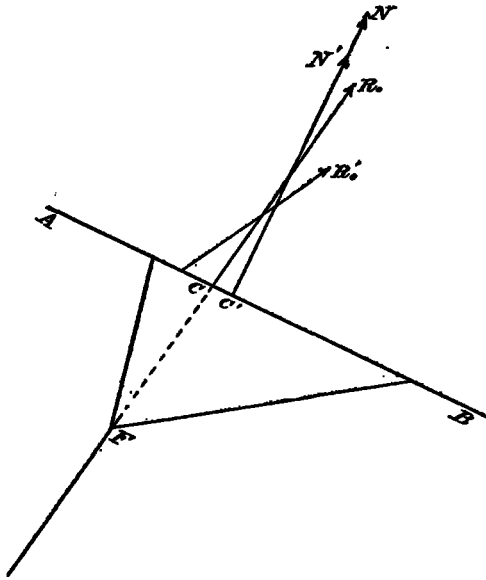

FIG. 11.

Fig. 11 shows diagrammatically the relation of the forces C' , N , and R_0 with the kite in equilibrium under the restraint of the string acting through the point F . A reduction in the wind force gives rise to the condition shown by the forces C' , N' , and R'_0 , which are no longer in equilibrium with the pull of the string. Before we discuss the motions that must ensue let us first follow the effects of a change in *direction* of the wind.

Variations of wind direction.—Any change in the direction of the lines of flow of the air, whether to the right or left, or in their upward or downward trend, has the same effect upon the wind forces as if the wind were constant and the attitude of the kite had changed in a corresponding manner. These effects are identical only to the extent of the wind forces; the gravitation and tail effects will be changed in relation to the other forces if the attitude of the kite is changed. Any change whatever in the direction of the wind is accompanied by such an alteration of the system of wind forces acting upon the sustaining surfaces of the kite that the *central axis* $S S$ of that system changes its position, and possibly its direction, depending upon the nature of the kite. If the kite contains but a single flat plane, the axis $S S$ will remain sensibly parallel to its original direction, but, in general, with kites whose surfaces are more or less curved the axis will not only shift its position, but will change slightly its direction at the same time. If the change in wind direction is wholly confined to a vertical plane, the point C' , Fig. 11, will move toward the *forward end* of the kite when the angle of incidence of the wind upon the surfaces *diminishes*, and *vice versa*. If the change is in the azimuth of the wind the point C' will, in general, shift laterally as well as forward or

backward. In kites having automatic lateral stability (page 154) the point C' must always remain very nearly at least in a certain longitudinal line, as explained more fully hereafter. We find, therefore, that with a change of wind direction, not only must the axis $S S$ shift its position and, in general, change its direction slightly, but the magnitude of the force N increases and decreases according as the angle of incidence of the wind upon the sustaining surfaces is increased or diminished by the change in direction. The distance that the point C' will move for a given change of incidence of the wind can be computed in certain cases by Lord Rayleigh's formula, equation (2), page 140. Its applicability, however, is exceedingly limited and restricted to single, narrow, rectangular, plane surfaces presented to the wind in a special manner. The formula is utterly inapplicable to the general case of kites. Similarly, the relative magnitude of the force N corresponding to a certain incidence can, under certain conditions, be computed by Duchemin's formula, but in this case, likewise, the proper application of the equation is so exceedingly limited as to be of little practical use in the present connection. There does not seem to be any thoroughly complete data available by which to determine, *a priori*, the exact changes in the position of C' or in the direction and magnitude of N corresponding to changes in the incidence of the wind.

We have already shown fully the effects on R_0 of a change in wind force. Not only will these results follow when the wind changes its direction, but there will be added to them similar and additional effects resulting from the movement of the point C' and the change in the direction of N . Moreover, important secondary effects will arise from the pressure of the wind represented by the series of disturbing forces we have designated e , f , n , v , and w . Especially is n , the pressure upon the neutral surfaces when present, likely to experience very considerable changes. The tail, also, will be blown off in a different direction, and while the force (7) may retain the same numerical magnitude, the *moment* of the force may change very greatly and in such a manner that the couple Z_0 , which is sensibly zero when the kite is in equilibrium, takes on a considerable plus or minus value, especially if the wind has changed its direction in azimuth.

Following a line of reasoning similar to that employed on page 149 in establishing the effects on the couple Z and the distance x , resulting from a change in wind force, it may be shown that with a change of wind *direction*, R_0 will be changed in magnitude, direction, and distance, x , from the force R , which itself shifts its position. If the incidence of the wind

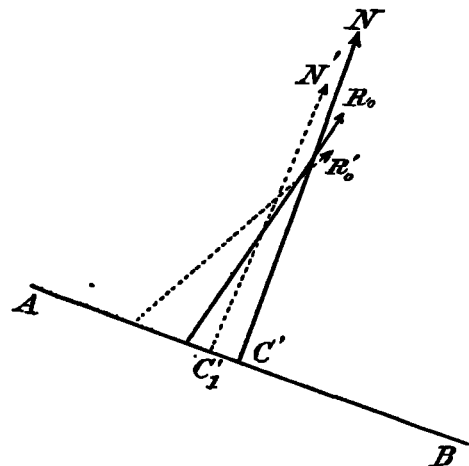

FIG. 12.

upon the kite surfaces is *smaller* as a result of the change in wind direction, then R_0 will become *smaller* and both R_0 and the point C' will move *toward* the front edge of the kite to such positions, for example, as shown at R'_0 and C'_1 , Fig. 12.

Except for the changes in Z_0 , these effects are identical in general character with those which result from a *diminution in wind force*. Similarly, a change in *direction* which causes the incidence of the wind upon the surface to *increase* can be shown to produce changes in R_0 , which are similar to those resulting from an *increase* of wind force. The tendency of the kite in the two cases to move will, however, be entirely different because the couple Z_0 is but little affected by a mere change of *force*, but may be greatly affected by a change of *direction*. It must not be forgotten that the several forces shown in the diagrams 10, 11, and 12 are not necessarily in the same, or even in parallel planes. If R_0 is in the plane of the diagram, then the other forces are in all probability not in that plane nor parallel thereto. It is not even probable that R_0 is in the plane of the diagram, because in that case the force would be in a plane perpendicular to the reference plane AB , and this could be the case under only the most perfect conditions of symmetry of the kite.

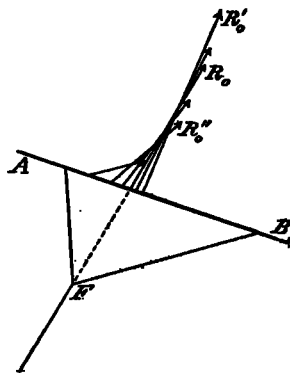

FIG. 13.

We have now fully set forth the general character of the changes in the resultant force R_0 and the couple Z_0 , corresponding to changes of either the force or direction of the wind. These results may be shown graphically, as in Fig. 13, in which the force R_0 is shown directly in line with the kite string passing through the point F . The kite is, therefore, in equilibrium. Several lines, R' , R'' , etc., show other possible values of the resultant force R_0 such as may logically arise from changes of the wind. While the disparity between these forces is exaggerated for the sake of clearness of the diagram, yet nothing impossible is there shown, and it must be remembered that no two of these forces need necessarily be in the same plane. Moreover, these are momentary states of the resultant R_0 , corresponding to sudden changes of the wind and obtain only until a change takes place in the position of the kite. The important feature brought out by our analysis, and to be noticed here, is that when the magnitude of the resultant R_0 *diminishes* its action line takes a more forward position and a direction more inclined from the vertical. On the other hand the opposite effects ensue when the magnitude of R_0 increases. Special cases may arise where simultaneous changes of both *direction* and *force* may tend to compensate and offset each other, respectively; but these are rare and unimportant and not general effects.

The ability of a kite to recover its equilibrium when disturbed by a change of wind conditions producing results such as shown in Fig. 13 depends upon the ability of the kite string to align itself with the resultant R_0 , whatever be the position and direction it may assume. Now, no two of the possible values of R_0 necessarily pass through a common point. In Fig. 13 there seems to be a tendency for the forces to cross each other behind the line AB , but when we remember that these forces are not necessarily in the same plane, we see that it is improbable that even any two of the forces intersect. Since the action line of the force exerted in the

kite string must always pass through the point F , where the string is made fast to the kite, it is obvious that no matter how the string may change its relations to the kite (which we still consider to remain fixed in position), or how the bridle may be arranged, it is impossible for the string, being in alignment with one value of R_0 , to align itself with any other value, except on rare and improbable occasions, such as referred to above. These results will follow under the condition that the position of the kite remains fixed, and it is important that they be fully recognized. Thus, if a kite were fixed in mid-air so that it could not change its position, a string could be tied to the kite in such a way that the string alone, without assistance from other means, could neutralize the action of the resultant force R_0 for *one particular value* only, but no matter how the lower end of the string were shifted about, if still fastened to the same point at the kite end, it would, in general, be impossible for the string to neutralize any other than one value of R_0 depending upon one condition of the wind. We thus see that mere changes in the angular relations between the kite and its string tied at a given point, F , are, in general, each and all inadequate to reestablish an equilibrium that has been disturbed by changes in the conditions of the wind. Only by a complete change in the attitude of the kite to the wind can equilibrium be again established.

Changes in attitude of the kite.—Whenever a state of equilibrium is disturbed by any cause and in such a manner that the resultant force is *diminished*, the action line will, as we have shown above, make a *smaller* angle with the general plane of the kite and its position will be farther forward, as shown in Fig. 14, in which R_0 is the resultant before and R' that after the equilibrium is disturbed; the gravity (2) and the tail force (7) are also shown.

If the string is attached at F then the kite will be moved in the direction indicated by the force at M , which can be fully determined by the methods already described on page 145. The force M in this case and the motions that ensue are of such a nature that the kite in its onward movement assumes a greater angle of incidence to the wind. This causes the resultant pressure of the wind upon the sustaining surfaces to increase and, as a further effect of the increase of the angle of incidence, the point of application of this force at C_1 , moves away from the front edge of the kite to such a po-

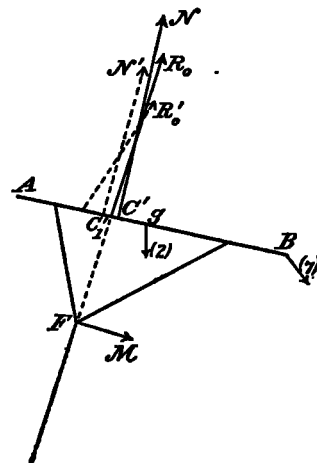

FIG. 14.

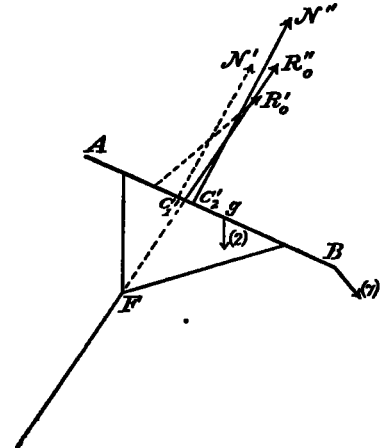

FIG. 15.

sition as C_2 , Fig. 15, which is supposed to represent the kite *after* it has moved to some new position and has changed its incidence to the wind. The pressure of the wind upon the sustaining surfaces before moving and after equilibrium was disturbed is shown at C_1, N' . The pressure after the kite has moved to its present position will be represented by a line, C_2, N'' , nearly parallel to C_1, N' but farther from the front

edge of the kite. The forces C' , N' , and R'_0 , in Fig. 15, are shown in their original relation to the reference plane AB . The absolute direction of these forces in the first or original position of the kite was, of course, more nearly vertical.

The change in the position of the kite effects the following changes in the relations of forces:

(a) The pressure of the wind upon the sustaining surfaces is increased in magnitude and its action line cuts the reference plane AB at a point, C' , farther from the front edge of the kite, and, in general, C' , will be nearer the center of gravity, g , of the kite.

(b) The forces (2) and (7), after the change in position, will be parallel and equal to their status before the change.

(c) In consequence of (b) and the shorter distance between C' , and g , the moments of the forces (2) and (7) will be smaller than before the change of position.

(d) Finally, as a general result of all the foregoing alterations the total resultant R''_0 will be greater in magnitude, its direction will be more nearly at right angles to the reference plane AB , and its position will be farther from the front edge of the kite than that of the force R'_0 , which is the state of the total resultant just after the equilibrium was disturbed and before the kite changed its position.

A similar line of reasoning may be employed to bring out the exactly opposite results that ensue when the equilibrium has been disturbed, because the resultant R'_0 , Fig. 14, has a greater value than R_0 .

It follows, as a natural consequence of the above results, that when the string is tied to the kite at some point, F , in front of, that is, on the windward side of the kite, the force M , whenever it has finite values, will tend to move the kite to a position in which the string and the total resultant R''_0 will exactly align with each other, as shown in Fig. 15.

Referring again to Fig. 13 it was shown in connection therewith that as long as the kite retained a fixed position the possible values of the total resultant R_0 were in such relation to each other that no two values could be neutralized by the string when attached to the kite at a single point, F . When, however, we permit the kite to move and change its attitude to the wind and consequently its relation to the action line of gravity and the tail force, it is possible to find such a position of the kite corresponding to each possible force and direction of the wind that the resultant will always pass through the point F .

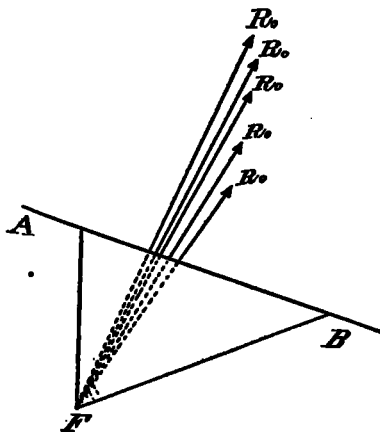

FIG. 16.

Fig. 16 shows numerous values of the total resultant R_0 , each corresponding to a certain force of the wind and a certain position of the kite. In the figure we can conveniently show the kite only in one position. The forces are, therefore, shown only in their relation to the reference plane of the kite, and we must imagine the kite to take as many dif-

ferent positions as there are forces shown, each for each. For each force and for each position the string can align itself with the force, and thus neutralize it, because all the forces are shown passing through the common point F . These forces are not necessarily confined to one plane. The whole problem of the ability of a string to neutralize the total resultant of all the forces of wind and gravity acting upon a kite depends upon the circumstance that a relation, such as shown in Fig. 16, is possible between the values that the total resultant R_0 can assume, no matter what the changes in conditions may be. The analysis is not limited to those circumstances that must prevail when the kite must fly upward or else dash itself against the ground, but finds its full application in the case of a kite string fixed to a point high up in the free air, in which case the kite can assume without interference any position the forces impose upon it.

We have thus fully set forth the general character of the changes among the forces acting upon any kite corresponding to such changes as may occur in the wind effects. The general conditions under which equilibrium may be established have also been shown.

Center of pressure.—We have already taken occasion to point out the indefinite, unphilosophical character of the expression "center of pressure" as applied to wind pressures upon kites. The idea that the "center of pressure" is a tangible conception is so generally prevalent that a few additional remarks upon the same subject may not be amiss. The sustaining surfaces of a kite are the origin and generating cause of the principal wind pressures acting upon the structure. When these surfaces are simple and consist of but a single plane, as indicated in Fig. 6, and if we think of the pressures upon this surface only, we may logically imagine all the elementary pressures concentrated and acting at a single point, as at C' , which we may then regard as "a center of pressure." The point, however, as we have shown, has no other mechanical significance than that it is an assumed point on the central axis of that system of pressures which act upon the sustaining surfaces. If any or all of the small disturbing forces which we have designated e , f , n , etc., have finite values, then some other point, C'' , not shown, will be "a center of pressure" for all the wind forces upon the whole kite. Again, if we include in our thought the attraction of gravity and the pull of a possible tail among the forces acting upon the kite, then another point, C , not necessarily coincident with either C' or C'' , becomes "a center of pressure," or, more logically, a center of forces. Finally, when the structure of the kite is complex, with superposed and separated supporting surfaces, we are quite unable any longer to follow out the analogy of a center of pressure or assign its location.

If the "center of pressure" of all the forces acting upon the kite is the desideratum, then it is the point C , for example, in Fig. 6, or it is any one of the points in Fig. 13 where the forces R_0 intersect the reference plane AB , or it may be any one of the points in Fig. 16 where the forces there shown intersect a reference plane which may be chosen anywhere at random. None of these points can logically be designated as centers of pressure because they depend upon the action of the tail of the kite, and upon gravity quite as much as upon wind pressure. The nearest approach to a center of pressure is the point we have designated C' , C'' , C''' , etc., Figs. 6, 10, 11, 12, 14, and 15, but even this is nothing but an assumed point of action of the resultant pressure upon the sustaining surfaces. If any one point of the kite is worthy of a special name on account of the distinctive properties possessed by it, then it should be the point F , whose properties are those of a real center of forces; that is, a point through which resultant forces constantly act. This is seen in Fig. 16. In another sense, however, F is simply a point of support of a body subjected to forces acting in an upward direction.

IX.—CONDITIONS OF STABILITY AND STEADINESS OF KITES.

Before we attempt to show how to impart stability to a kite, that is to establish in general those conditions that will enable the kite to maintain its equilibrium under variations of the wind and changes in the position of the kite, it is important to clearly point out upon what *stability* depends and show when the terms *stability* and *steadiness* may have distinct applications.

When employed in the technical sense, *stability* has reference to a state of *stable* equilibrium, and, as is well known, the equilibrium of a body is *stable* whenever, if displaced from its condition of rest, the body tends to resume its original attitude. When we deal with the equilibrium of ordinary objects supported against gravity, or of vessels floating upon liquids, or of objects sustained in the air, as in the case of balloons, for example, the whole quality of stability results whenever a certain relation is established between two forces, namely, the force of gravity acting at the center of gravity of the body and the resultant of the system of supporting forces. This relation is such that the applied forces will always restore a displaced body to its original attitude, whenever the disturbing cause is removed or will automatically establish a new position of equilibrium when natural changes occur in the system of applied forces. The case, however, is very different when we consider the equilibrium of a kite. Here, as has been fully shown in the preceding pages, we must deal with two separate and distinct conditions of equilibrium, that is, not only must the restraining pull of the string, which is the supporting force, neutralize exactly the resultant R_0 of the complex system of the applied forces, but the resultant couple Z_0 of that system must also be zero at the same time. The entire independence of these two conditions of equilibrium must be fully recognized. All the kite string can do toward bringing about a condition of equilibrium is to neutralize the force R_0 . Except for the very feeble and wholly insufficient resistance it may offer to being twisted or untwisted, the string is utterly powerless to oppose, in any way, the action of the couple Z_0 , which, when the kite is otherwise in equilibrium, tends to produce rotation around the string as an axis. It therefore happens, in the case of a kite, that we may establish between the string and the resultant R_0 all those relations that in ordinary cases are sufficient for a state of stable equilibrium, but the kite may, nevertheless, dart about in the most restless and erratic manner imaginable, simply because the couple Z_0 may have finite values when R_0 is neutralized, and *vice versa*. We thus observe that the two conditions essential to the equilibrium of kites give rise to two independent sets of conditions that must be separately established to produce stability. One of these is the set of conditions, in consequence of which the string can neutralize the resultant force R_0 under all variations of the wind and changes in the position of the kite. The other is the set of conditions that must be provided in every kite, and by virtue of which the couple Z_0 , whenever it temporarily acquires finite values because of changes in either the wind or the position of the kite, is immediately reduced to zero in consequence of the incipient rotation resulting from its own action.

The complete stability of the kite results only when both the above mentioned sets of conditions are fully established. Even under these circumstances, and notwithstanding that its equilibrium is perfectly stable in every detail, the kite may not poise in that comparatively motionless manner which the word *stability*, when applied to kites, is intended to imply. This paradoxical result will arise whenever the force R_0 is neutralized with the kite in one position while the couple Z_0 becomes zero only with the kite in a different position. The kite will then execute those rythmical, periodic,

pendulous movements already referred to in the paragraphs on darting on page 147.

Hereafter, therefore, if a kite poises in a nearly motionless attitude we shall say that it flies *steadily*, or that it is steady. On the other hand, it will be an *unsteady* kite if it constantly shifts about in a pronounced and restless manner.

It should be noticed that if the words are used in strict accord with their technical meaning, the slightest disturbance will completely overthrow the equilibrium if it is *unstable*, and an unstable kite would be wholly unable to fly at all. If, however, its equilibrium is *stable* the kite is bound to fly somehow, and it will fly steadily whenever the wind is steady and the force R_0 and the couple Z_0 are simultaneously neutralized.

An important step is taken toward reaching a clear understanding of how to control the flight of kites when the two independent conditions for which *stability* must be established are thoroughly differentiated and when the distinction between *stability* and *steadiness* is recognized.

We need very badly two good words that shall be descriptive of the two independent sets of conditions by virtue of which stability results. In the one case stability is established wholly with respect to the action of the resultant force R_0 , and in the other with respect to the couple Z_0 . Recognizing that R_0 tends to produce translation only and that the couple Z_0 produces only rotation, the expressions, *translational stability* and *rotational stability*, suggest themselves, and, in the absence of better terms, these will be used.

Translational stability.—Under this topic we shall discuss simply those conditions which will produce states of stable equilibrium with respect to the action of the resultant force R_0 .

Whatever the force or direction of the wind may be there is always a corresponding position and attitude of the kite in which the total resultant R_0 of all the forces acting upon it will pass through a point F , Fig. 16, at a greater or less distance in front of the kite surfaces. F may have many different positions with respect to the kite, each giving rise to its own corresponding positions of steady flight.

We have already fully shown that whenever the point F is at some distance in front of the surfaces of a kite the action of the forces when not in equilibrium will always tend to move the kite into a position and attitude in which the resultant force R_0 is fully neutralized by the action of the string. This being the case, the equilibrium of the kite with respect to the force R_0 is, therefore, *stable*; that is, a condition of *translational stability* is established simply by giving the point F a position well in front of the kite surfaces. On the other hand, the equilibrium will be *unstable* when F is near to or behind the kite surfaces. A true state of neutral equilibrium is not possible in the case of a kite. As the point F approaches nearer and nearer to the surface of a single plane kite the equilibrium presently becomes only partly stable; that is, the equilibrium is *stable* for some conditions, but *unstable* for others; whereas, when F is quite behind the kite as a whole, the equilibrium is *unstable* for all conditions.

Considering only the resultant force R_0 of the system of forces acting upon a kite, we may therefore say that the *stability* of the kite is assured whenever the point F (which may be defined to be the point at which the string ends and the kite actually begins) is fixed, or at least constrained, in reference to the kite structure and is in front of the kite.

Stability with bridles of different types.—The manner of attaching the string to the kite, therefore, wholly determines whether the translational equilibrium will be *stable* or not. In a single surface kite F must be in front of that surface, but it need not necessarily bear a fixed relation to that surface. In kites with superposed surfaces F may be within or even behind the lowermost surfaces without wholly impairing

the quality of stability. In these cases an actual bridle may not be employed at all, but the string may be fastened directly to some stick of the kite, and the point F will then, in general, bear a fixed relation to the kite structure. Most other methods of attaching the string are generally reducible to a condition that the point F is free to move in a circular arc, the plane of which is perpendicular to a line which itself bears a fixed relation to the kite and also contains the center of the arc. The bridle on a malay kite is a typical bridle answering these conditions, but obviously other forms are possible. In whatever manner the string may be fastened to the kite the point F is either fixed in reference to the structure, or it is permitted to move in relation thereto only in some constrained manner. Peculiar and rather complex cases of constraint arise in the case of the use of dual and triple strings. Different methods of bridling and restraining the kite give rise to different conditions under which stability is possible. The conditions of stability and equilibrium with dual and triple restraining lines were presented on page 145. Other cases are briefly discussed as follows:

(a) *When F is a fixed point.*—When the string is tied to a fixed point of the framework, as may be the case in cellular kites, or to bridles such as shown in Fig. 6, then, as we have found, the equilibrium will be *stable*, because a reasonable disturbance of the relation of the forces is accompanied by a tendency to restore equilibrium. In the case of the kite this tendency may be nullified and made ineffectual because of the presence of a disturbing couple, but the equilibrium is of a *stable* character nevertheless.

(b) *When F is not a fixed point.*—When a bridle is made of a single bight of string, the point F will no longer bear a fixed relation to the kite, but will be free to move in a circular arc, as described above. For the equilibrium of the kite to be *stable* under these circumstances, it is necessary that the central axis of the whole system of forces shall always pass through the fixed line joining the extremities of the bridle and fall between those extremities. This will be understood from Fig. 17. The bridle is fastened at AB and the string at

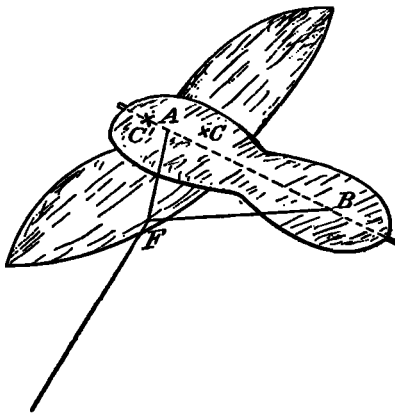

FIG. 17.

F . If the *central axis* of the system of forces passes at one side of the line AB , as, for example, at C , or beyond either extremity of that line, even if on the line, as at C' , then it is impossible for the kite to assume a flying attitude, simply because the action line of the string can not pass through the point C or C' , as is necessary for equilibrium.

In order that a kite with a bridle of this type may fly at all, it is necessary to employ some artifice that will cause the central axis of the whole system of forces to always pass through the line AB and within its extremities. We will discuss more fully the nature of such an artifice in the next paragraph. This essential condition being established and

the point F being in front of the kite, then, as before, the equilibrium will be *stable*, because the forces will both move the kite and alter its attitude to the wind until the string and the resultant force R_0 come into alignment, and thus produce equilibrium.

That quality of the kite by virtue of which the resultant force R_0 is made to always pass through the line AB , joining the extremities of the bridle, is generally known as its *lateral stability*.

The *lateral stability* becomes a question that requires separate consideration only when bridles are employed which do not restrain the point F laterally. When F is rigidly fixed in reference to the kite structure, then both *lateral* and *longitudinal stability* are equally provided for. Whenever F is fixed in only a longitudinal sense, as in the present case, then *longitudinal* but not *lateral stability* is assured.

If it were customary to bridle a kite with a single bight of string having its two ends made fast to the framework at two lateral points, then we would need to separately consider *longitudinal stability*. This, however, is not the case, and we will only remark further in this connection that both lateral and longitudinal stability are simply component parts which together make up that quality which we have called *translational stability*.

A simple and comparatively effectual method of securing lateral stability in single surface kites is to dispose the lateral halves of the kite in such a manner that the surfaces form a dihedral angle with each other. In this case, when one side temporarily receives a greater pressure than its fellow the kite is tilted laterally, and the side moves into a position of less inclination to the wind, the intensity of pressure thereon being thus diminished, whereas, the opposite side is placed by the tilting in an attitude of greater inclination to the wind and receives a corresponding increase of pressure. A balance between the opposing forces on the lateral halves of the kite is thus preserved. In the malay, Eddy, and many different forms of oriental kites the dihedral angle is produced mostly by springing the cross stick or sticks of the kite into a bow of slight depth with the convexity presented to the wind. The slight angle thus made possible between the lateral halves of the kite is, however, in general, made more effectual by the bagging of the covering, which is often intentionally fitted somewhat loosely. In many cases the cross sticks are not originally bowed, but are sufficiently flexible to bend when strained by the wind, and thus form the necessary dihedral angle.

Even at the best kites of this type can acquire by means of the dihedral angle resulting from the bowed cross stick and the loosely fitted covering only slight degrees of lateral stability. The idea is current with some that flexible, yielding frames, *per se*, give rise to remarkable degrees of stability. This is, however, hardly the case. It is true that the stability of a flat, or nearly flat surface, will be greater, provided the lateral halves of the surface when strained can bend backward. The increased stability, however, never results from the mere yielding of the surface under strain, but comes about wholly from the dihedral angle effect made possible by the bending. If the surface were originally made rigid and of the exact form assumed by the bent pliable surface then the stability of the two would be exactly the same with the further advantage in favor of the rigid surface that when the force of the wind falls off and the bent surface relaxes, it loses part, at least, of its stability, while that of the rigid form is fully preserved. In any case, all kites which depend upon such expedients for lateral stability are only slightly stable flyers. Vastly better methods of contributing stability are well known and will be mentioned farther on.

The mechanics of lateral stability is readily understood from Fig. 18. Let BD , at (a), Fig. 18, represent an edge view

from the front of a kite composed of but a single plane surface. Let the two extremities of the bridle be tied at points $A A'$, both represented at A , one of the points being directly behind the other. We may, therefore, regard A as the end view of a longitudinal axis about which the kite is perfectly free to tilt laterally. A slight inequality in the amount of surface in the lateral halves of the kite, or a temporary intensity of pressure of the wind upon one half greater than on the other will cause the resultant R_0 of all the forces to act through a point C at one side of A . The force R_0 , therefore,

faces will, in general, be possible in which the *central axis* of the entire system of forces passes through the axis of support $A A'$. There is no essential difference in the mechanics of the question for the case in which the neutral surface is made in the form of a dorsal fin, as shown at (b). Similarly, neutral surfaces at the sides of the supporting plane $B D$, as shown at (c), also contribute lateral stability, and the addition of a single surface, $B' D'$, as shown at (d), produces one of Hargrave's rectangular cells. It is not at all remarkable that the cellular kites should be so very stable when we notice the relatively great extent of neutral surfaces in a cell and compare the considerable power of resistance these surfaces can offer to lateral tilting of the kite with the corresponding feeble opposition possible in the case of a very flat dihedral angle or the even slighter resistance possible in those kites which depend upon the uncertain pliability of lateral wings. It is but a single step from the dihedral angle at (e) to the diamond cell at (f), and the trapezoid at (g) is another obvious combination, which, by the way, possesses remarkable stability. Each of these forms possesses the quality of lateral stability, because whenever the resultant force R_0 does not act through the longitudinal axis of support, as $A A'$ in (d), (f), (g), Fig. 19, the kite will be tilted and a new force called into action, which, with a certain amount of tilting, will be just sufficient to restore equilibrium; that is, to cause the total resultant of all the forces to pass through the axis of support, $A A'$. A single cell, bridled in the manner shown at (d), in steady winds is a perfectly stable structure, both laterally and fore and aft. It will be so even if the string be tied at some single point between A and A' . In general, however, a single cell can not be made to fly well, or even at all, but this is chiefly because the resultant couple Z_0 of the system of forces is generally of finite value, and there is little or nothing in the relation of the forces of the system to automatically neutralize this couple.

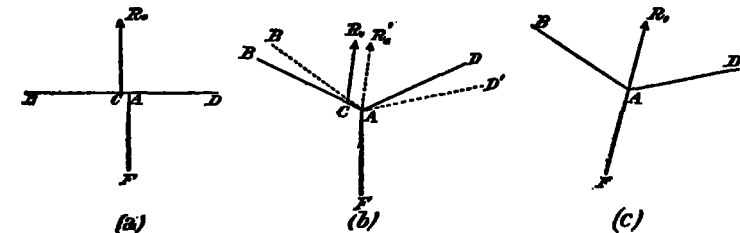

FIG. 18.

acts upon a short lever arm, $C A$, and tends to rotate the kite around A as an axis. Any tilting of a plane surface in a *strictly lateral* sense, that is, about an axis such as A , which is considered to be in a plane parallel to the lines of flow of the wind—any such tilting affects all parts of the surface alike, and the resultant force R_0 will continue to act through sensibly the same point, C , whatever the position of the plane may be. Lateral stability of a perfectly flat surface supported in the manner now supposed is, in fact, impossible. If, however, the lateral surfaces are inclined to each other, so as to form a slight dihedral angle, as at (b), Fig. 18, then, whenever the resultant R_0 acts at some point C not in the axis A , the force R_0 will still tend to rotate the surfaces about A , as before, but, when the surfaces have moved to some new position, as shown by the dotted lines, the portion $B A$ will have a less and $A D$ a greater inclination to the wind than previously, and in consequence, there is always some attitude of the surfaces in which the resultant R_0 will pass through the axis A . In the meantime, or subsequently, the kite, as a whole, will be translated to a position as shown at (c), Fig. 18, where the plane of the bridle, $A F$, contains also the force R_0 , one condition essential to equilibrium. Other means than the dihedral angle may be resorted to for the purpose of producing lateral stability. Some are indicated in Fig. 19, (a) to (g).

We have thus fully analyzed and discussed first the effects of changes in the wind and position of the kite upon the applied forces, and then shown in detail all the essential conditions and circumstances under which the equilibrium of the kite can be stable with respect to the resultant force R_0 . To this end it is necessary only that the point F at which the string ends and the kite begins shall be in front of and not too near the supporting surfaces of the kite. If F is not fixed in a lateral sense, then we must establish conditions of automatic lateral stability, as described in detail above. By these methods the so-called *translational stability* of any kite may be fully and certainly established. It now remains to show how the resultant couple Z_0 may be neutralized when it attains finite values owing to changes of the wind, etc.

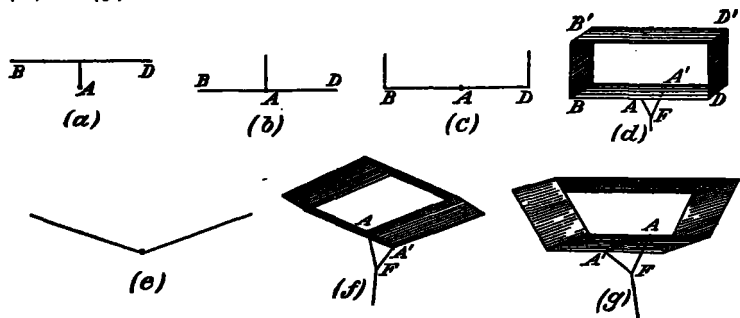

FIG. 19.

Surfaces set edgewise to the wind, but perpendicular to the sustaining surfaces, have been called "neutral surfaces" in the preceding pages. These, in general, contribute lateral stability as well as serve other functions. At (a), Fig. 19, we have shown a sort of keel attached to the sustaining plane $B D$. Under normal conditions the pressures on the opposite sides of such surfaces will be equal, but if the structure is tilted about a longitudinal axis, as at A , then one side of the neutral surface begins to experience an excess of pressure that tends to oppose the tilting, and a condition of attitude of the sur-

Rotational stability.—When kites are in equilibrium the action line of the string is then the *central axis* of the whole system of applied forces, and, ordinarily, stands roughly at right angles to the general plane of the kite surfaces. The axis of the couple Z_0 is not only necessarily parallel with this central axis, but in kites coincides with that axis itself because the kite is free to turn only thereon. Our purpose is now to discuss the means that may be employed to prevent or to properly regulate and control this turning, that is, to establish rotational stability.

If it were possible to make a kite such that the resultant couple Z_0 of all the forces would always be zero, no matter how the conditions of wind might change or how the kite might be turned about the string as an axis, then we might say that the rotational equilibrium of such a kite is perfectly neutral. On the other hand, if the couple Z_0 retains a finite value, no matter how much the kite may turn under the action of the couple, then we should say its rotational equilibrium is *unstable*. If, however, as the turning of the kite pro-

ceeds under the action of the couple Z_0 , the latter, as a necessary result of the turning, is reduced in magnitude and made zero, then the rotational equilibrium is stable.

Function of the tail.—The whole useful function of the tail is to suppress and govern the action of the couple Z_0 . In every other respect the tail is a useless and even objectionable appendage to the kite, but if it is properly adapted to its purpose the couple Z_0 , when momentarily of finite value, is immediately reduced to zero, as a result of the action of the tail under the incipient rotation which ensues. This is readily understood from Fig. 20.

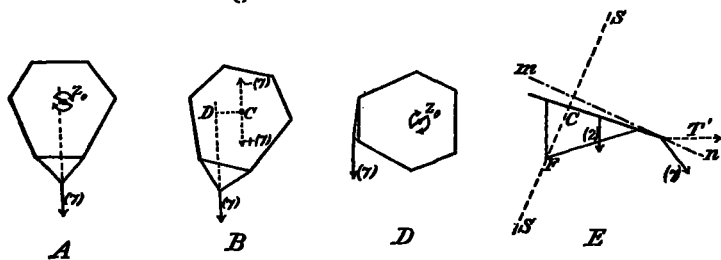

FIG. 20.

At A is shown a kite as it may appear when viewed exactly in line with the string, which intersects the kite at C. The force (7), due to the tail and the couple Z_0 , are also shown. There being nothing initially to oppose the action of the couple, when its value becomes finite, the kite turns a little, but immediately that this occurs the action line of the tail force, (7), passes more and more to one side of the central axis of the system of forces, as shown at B, Fig. 20. The force is thus made to act at the end of a short lever, or moment arm CD and if the tail be adequate for its purpose, a slight turning of the kite causes such new relations between the forces, including that of the tail, that the resultant couple Z_0 , which had momentarily attained a finite value, is reduced to zero. The action of the tail is in these cases equivalent to a couple as may be easily shown by introducing at C two forces, $+(7)$ and $-(7)$, equal and opposite to each other, and equal and parallel to the tail force (7). The latter force and the force $-(7)$ at C, constitute a couple with the moment arm CD . The change in the position of the kite, resulting from the turning, has quite disturbed the equilibrium of the force R_0 , but this is of no consequence, since the relations of this force to the string are those of stable equilibrium and a new position of rest will be quickly assumed. The important point is that in consequence of the action of the tail the couple Z_0 is prevented from maintaining a finite value for any considerable time. It must be noted, furthermore, that the couple-action of the tail does not have an independent existence. It is called into action by the general couple Z_0 of the whole system of forces. If the latter couple increases or diminishes, or changes sign, so does that due to the tail. The existence of the couple Z_0 results, in the main, from imperfections in the symmetry of the kite and from temporary inequalities in the wind forces at different points over the kite; also, from changes in wind direction. Z_0 is therefore, not permanently a very powerful couple, and, in consequence, a slight shift of the kite, of the nature shown at B, will, as a rule, effect its elimination, provided the force (7) is relatively considerable. The tail produces the maximum possible couple when in the position shown at D, but such an extreme turning of the kite is, of course, fatal to satisfactory flight. The usefulness of the tail depends upon its power to neutralize the couple Z_0 with only very small angular turnings of the kite. Gravity may also assist the tail in causing a couple to vanish. This is generally the case, because in most kites the central axis is nearer the forward edge than is the center of gravity. The action of gravity in this connection, and some further facts

concerning the effect of the tail will be understood from an examination of E, Fig. 20, which shows the side view of the kite and string. It is a well-known result that gravity, acting at a point, g , on a body like AB , free to rotate about an axis such as SS , will make the body take a position about that axis such that g , when the kite is in its normal flying attitude, will be the lowest possible, or very nearly so. A couple such as Z_0 , which tends to produce rotation about the axis, SS , must, in turning the kite, carry the point g to a higher position, and to this extent the turning will be opposed by gravity. The opposing power of gravity has, in general, however, only a relatively feeble moment of little importance. Our only object has been to call attention to its existence, as the principle may have great importance in the flight of birds and flying machines of considerable weight.

It should be noticed that, in general, the direction in which the force (7) due to the tail acts makes an angle below the horizontal, as shown at E, Fig. 20. In considering the effectiveness of the tail to nullify a couple, the force (7) must be resolved into two components, one parallel to the axis SS , and the other in a plane, mn , perpendicular to SS . The moment of this latter force with respect to the line SS is the only effective part of the force (7). The most effective tail is, therefore, one which would dispose itself in the plane mn , in which case the full power of the force (7) is effective in suppressing rotation. However necessary and useful the tail may be in contributing to the rotational stability of a kite, it is very plain that its force, (7), as may be seen in Fig. 4, tends to very strongly deflect the resultant R away from the normal N , and thus impair the effectiveness of the kite. If the pull of the tail could be upwardly inclined it would be much better, as there would then be exerted an advantageous lifting tendency. But this is, of course, impossible as a steady effect, unless, for example, the tail was rendered buoyant by inflation with gas.

Most efficient tails.—Now that we know the exact function of the tail we are prepared to state the conditions for maximum effectiveness. In the first place the necessity for a tail arises from the fact that, owing to some organic, permanent, and constant defect in the kite, the structure is unsymmetrical, and in consequence the couple Z_0 still exists when all the conditions of equilibrium are otherwise established. This couple may also assume relatively large temporary values when the wind suddenly shifts its direction in azimuth, as explained on page 150. The power of the couple will, on the average, be constant for a given wind force, although its momentary values will change more or less with inequalities of wind pressure on different parts of the structure. The power of the couple will also increase and decrease with the wind velocity. Now a tail which depends largely upon its weight for the force (7) will exert a nearly constant pull. In light winds it will pull the kite down and be unnecessary, while in heavy gusts it will be inadequate to overcome the increased moment of the couple Z_0 .

The most efficient tail, therefore, is one without weight and whose pull depends upon the pressure of the wind. When properly adapted to a given kite for one wind velocity it should answer equally for other velocities, at least within comparatively wide ranges.

Tails made of very light pervious cloth in the form of frustrums of cones distended at the base by a large and at the summit by a relatively quite small ring of aluminum wire or rattan are seemingly the most efficient tails. Their weight may be reduced to the minimum and the pull they exert is nearly proportional to the wind force and nearly horizontal in direction.

Tails thus afford a means of controlling and regulating the magnitude of the resultant couple Z_0 of the system of applied forces. The rotational stability may, however, also be

established without the use of a tail, and this brings us to the consideration of a new class of kites.

Tailless kites.—From the mechanical point of view the presence or absence of a tail in the case of a kite is simply a question of the magnitude of the force (7). Thus far we have supposed the force (7) to have a finite magnitude; we will next consider those cases in which $(7)=0$. This supposition that $(7)=0$ is all that is necessary to adapt the whole foregoing theory to tailless kites.

Referring to Fig. 10, showing the relation of the forces on a kite, it will be recalled that the central axis, $S_0 S_0$, of the whole system of forces is parallel to the force $C' R$, and separated from it by a distance, x , depending upon the nature of the couple Z . If now the force (7) is zero, then the line $Q R$ of the polygon of forces, which line is equal and parallel to (7), will vanish and the resultant of all the forces that remain will be represented by a line $C' Q$ instead of $C' R$. The couple associated with the new resultant, $C' Q$, will, of course, have a value depending upon the forces of wind and gravity on the kite alone, exclusive of the tail. Likewise, the new central axis will be parallel to $C' Q$ and a change will occur in the distance, x , corresponding to the difference between the new and the original couple Z . Finally, the resultant couple Z , acquires a new value and may even change its sign.

We thus find that if we omit the tail from a kite, other things remaining the same, the total resultant of the applied forces may be greater in magnitude, will assume a more nearly vertical direction, and will shift its position. Supposing the kite is able to fly either with or without a tail, it follows from the above that, if the incidence of the kite surfaces to the wind and other things be kept the same, the kite will often pull harder and always fly higher without than with the tail. Removing a tail from a kite or adding it thereto will, in general, cause the kite to assume a different angle of incidence when equilibrium is attained. This may be offset by a corresponding change in the bridle or it must at least be taken into consideration if we wish to compare the behavior of the kite in the two cases.

Such are the general relations between the forces acting upon a kite with and one without a tail. Our particular purpose at present, however, is to show what contributes to the rotational stability of tailless kites.

The rotational equilibrium of all flat surface kites, of which the form shown in Fig. 6 may be regarded as representative, is always likely to be quite unstable without a tail. The couple Z_0 , when finite is free to turn the kite about the string as an axis and generally to an indefinite extent. It is conceivable that the symmetry of such a kite may be so perfect that the couple Z_0 can not have permanent finite values under steady winds, or that the values may be so small that the feeble opposing couple resulting from the action of gravity may suffice to prevent rotation. These are not probable cases, and while a very slight degree of stability may thus be gained, yet, in fact, as every one knows, a kite of this type with insufficient tail is likely to dart about in the most unsteady manner and, if without any tail whatever, will often spin about the string as an axis at a very high velocity.

It is possible to contribute a slight degree of rotational stability to a flat surface tailless kite by adding weights to the aftermost end of the kite, and this method has sometimes been adopted. It increases the gravity of the kite, and shifts the center of gravity to a point farther aft, and therefore, as a rule, farther from the axis of the couple Z_0 , which is the central axis of the system of forces. Both these effects increase the relatively feeble opposition that the action of gravity on the kite offers to its being rotated out of a position in which the center of gravity is the lowest possible.

Another method is more generally employed, which also gives only a slight degree of stability. It consists in arrang-

ing loose flaps of cloth or covering material near the after end of the kite. The kite itself is sometimes made flexible in the aftermost portion by shaving the sticks down thin and attaching the bridle strings at some distance from the ends. In either case, these flexible portions flap and flutter in the wind to a greater or less extent, and thereby exert a small force approximately in the direction in which the air is flowing over the surfaces. Some mention has already been made of this point under the discussion of waviness and fluttering on page 141. The force, in fact, is not unlike the regular tail force (7) and acts exactly the same, but in a less powerful manner to suppress the couple Z_0 , that is, to keep the kite headed to the wind.

Loose fluttering appendages of this character are conspicuous in many different forms of chinese, bird, and butterfly kites, and in still other forms of oriental kites. In many cases the flaps are so disposed that under the pressure of the wind the surface is formed into dihedral angles near the aftermost portion of the kite, and, even if the loose material does not flutter and vibrate, the action of the side thrust of the wind on the slightly inclined surface at the back end of the kite tends to prevent rotation of the kite about the string.

Such means as we have just discussed will suffice to control flat surface kites in moderate winds, but will generally prove inadequate in strong gusty winds, and in such cases tails must often be called into requisition.

Dihedral angle.—We have already shown that a degree of lateral stability is imparted to a kite by placing the lateral halves of the surfaces at a dihedral angle with each other. This arrangement also produces a degree of rotational stability. All those kites of which the malay and Eddy kites are typical, including many oriental tailless kites whose framework is pliable and yields under the strain of the wind so that the lateral surfaces form a dihedral angle, acquire a degree of rotational stability as a result of this disposition. It is well known that these kites fly best when the covering material is pliable rather than stiff. It should be tense and fit closely over the forward portion of the kite and be loose and form concavities in the rear part. Under the pressure of the wind the loose and pliable covering forms a sort of keel, especially pronounced along the after portion of the midrib or upright stick of the kite. If the kite turns a little under the action of the couple Z_0 when its value becomes finite, the keel must swing sidewise against the wind and a very little turning under these circumstances reduces the couple Z_0 to zero. It is especially because the keel is deeper and more pronounced when the cloth is pliable and loose, that all these kites then fly better.

In considering questions of rotational stability in kites of the malay or Eddy type it should be noticed that the action line of the string, that is, the central axis of the system of forces and also the axis of the couple Z_0 , cuts the surfaces at a point only a short distance to the rear of the cross stick of the kite. This position is relatively close to the front edge of the kite, whereas, the keel-like disposition mentioned above is most conspicuous well toward the after end of the kite, a relation which is most effectual in producing rotational stability.

Boynon fin kites.—The use of genuine keels or fins, especially if they are cut away forward and are present only in the after parts of the kite, are still more effectual in suppressing the couple of the system of forces, and they may easily be arranged so that the kite to which they are attached can fly without a tail. The same remarks are equally true of the bipolar kite.

Bipolar kites.—In these the central spine is extended aft beyond the body plane and carries both a vertical and horizontal plane. The vertical plane, on account of its consider-

able distance aft from the central axis of the forces, affords a very powerful control upon the rotation of the kite under the action of the couple Z_0 .

Cellular kites.—We have already remarked that the great stability of the Hargrave kite results from the relatively great extent of neutral surfaces composing the lateral sides of the cells. The presence of these not only establishes a great degree of lateral stability, as already explained, but the neutral webs in the aftermost cell also act in the most advantageous manner to produce *rotational stability*, as is readily understood from what has been said above concerning the action of keels, fins, etc. Longitudinal stability results both from the superposition and the separation of the supporting surfaces and also from the use of a bridle, causing the point F , at which the main line is attached, to fall in front of the kite.

Steadiness.—The quality of steadiness in flight depends, as we have seen, upon the circumstance that the couple Z_0 and the resultant R_0 are *simultaneously* neutralized. Very many forms of kites are deficient in *rotational stability*, and slight inequalities of wind force very easily turn them considerably about the string as an axis. This alters the attitude of the kite to the wind, and thus causes the kite to shift its position in order to reestablish *translational equilibrium*. The greatest steadiness results when the *rotational equilibrium* is the most stable. This is why kites with an abundance of tail power fly so much more steadily than those with deficient tails.

The foregoing exposition of the action of the forces of wind, gravity, and the string upon kites suffices, we believe, to fully explain their behavior under all circumstances. The analysis of the conditions upon which stability and steadiness depend embraces every type of kite, not only the numerous odd forms constructed by the Chinese and Japanese, which, in many cases, are only adapted to sport and often fly at relatively low angles of elevation, but includes also the Malay, the fin, the bipolar, and all forms of cellular kites. We have aimed in our presentation of the mechanics of kites to state the generic relation and interaction of the applied forces. The principles thus laid down have a very wide and comprehensive application.

Numerical data.—In regard to the questions raised in Mr. Chanute's letter at the head of this memoir as to the positions of the center of gravity, center of pressure, and best point of attachment for the string, we may repeat here a statement already made that, in general, it is better to have the center of gravity fall farther aft than the so-called center of pressure, as gravity then assists in producing rotational stability. This position generally comes about without design on the part of the maker, but it is conceivable that a kite with a tail might fly with the center of gravity even forward of the center of pressure.

The indefiniteness of this conception, "center of pressure," has already been fully discussed. A *central axis* is the idea to be kept in mind in this connection, and if we include all the forces of wind, gravity, and tail, the central axis always coincides with the action line of the string when the kite is in equilibrium. As we have shown, the position and direction of this action line changes with every change in the force and direction of the wind and variation in the attitude of the kite. The central axis may be completely located in a given case by simultaneous measurements of the incidence of the kite, its angular elevation, and the inclination of the kite line at the reel. The axis always passes through the point F , at which the string is fastened to the kite. Methods of making the simultaneous measurements for this purpose have been fully described by the writer in "Kite Experiments at the Weather Bureau," pages 82 to 87 (reprinted from the MONTHLY WEATHER REVIEW, 1896, Vol. XXIV, p. 240), and it seems unnecessary to repeat the descriptions here.

The best point of attachment for the string depends partly upon the use to which the kite is to be put. Changes in the point of attachment cause changes in the angle of incidence which the surfaces assume to the wind. For reaching great altitudes certain angles of incidence are better than others. This subject has also been fully discussed in the pamphlet referred to above, and the results will be found on pages 98 to 103 (see MONTHLY WEATHER REVIEW, Vol. XXIV, p. 250). To repeat these demonstrations here will greatly extend the limits of this paper, and appears unnecessary.

X.—NUMERICAL DATA.

The gathering of numerical data derived from actual observations made by sound and accurate scientific methods is a matter of considerable labor and difficulty. Work of this character done by the writer for the Weather Bureau, in order to determine the efficiency and availability of kites for reaching high altitudes, has thus far extended only to various types of cellular kites, which, as a class, all things considered, are probably the most stable and available of all. Very complete numerical data respecting these kites have been published in the "Kite Experiments," pages 56 and 87 (see MONTHLY WEATHER REVIEW, Vol. XXIV, p. 244). The following additional example is cited from recent work:

Hargrave rectangular cell.—Each cell 78 inches from side to side; 32 inches from top to bottom surfaces. The cambric cloth bands, including the flat, spruce sticks ($\frac{1}{2}$ by $\frac{1}{4}$ inch) in the form of rectangular frames, with which the cloth is edged all around, are 25.2 inches (2.1 feet) wide. The front cell has a third sustaining surface midway between the upper and lower surfaces of the cell. The two cells are connected by a longitudinal truss. The upper and lower spines are spruce sticks ($\frac{1}{2}$ by $\frac{1}{4}$ inch) spread out by four columns and properly braced by wire ties. The extreme length over the cells is 79 inches. This kite contains 68.2 square feet of sustaining surface, and weighs 7.32 pounds, viz., 0.107 pound per square foot. The bridle is made of a single bight of string attached to the front and rear edges of the lower side of the front cell. The center of gravity is 1.6 inch forward of the center of figure. By actual observations in a wind of from 12 to 15 miles per hour the *central axis* of the system of forces was found to make an angle of 83° with the general plane of the sustaining surfaces, and intersected the lower surface of the front cell at a point 8 inches aft of the forward lower edge. The angle of incidence of the kite averaged 24.8° , and the pull, which varied greatly, averaged about 25 pounds. The efficiency of the kite was 92 per cent.

The simultaneous observation of all those elements of the flight of a kite that are necessary in order to accurately determine "the pull thereon, with various positions and with various strengths of wind," in its broadest sense, is equivalent to the determination of the law of relation between wind velocity and the pressure upon the surface of the kite at various angles of incidence. This is a matter which, if the results are to possess real scientific value, presents very serious experimental difficulties which are greatly aggravated by the extreme variability of the wind. Simple methods that may be imagined to give sufficiently approximate results are found upon trial and critical inspection to be exceedingly unreliable, and to yield widely misleading numerical values. The pull, if measured at the reel, must be reduced to its corresponding value at the kite, and the simultaneous velocity of the wind must also be definitely measured *at the kite*. Due allowance must be made for the weight of the kite, and the fact that in cellular kites the pressure of the wind per unit area upon the surface of the forward cell is much more intense than upon that of the rear cell must be properly recognized if the final results are to be susceptible of useful application in other cases. Investigations have shown the writer at least the real experimental difficulties of securing accurate data of this character, and he is not prepared at present to cite results whose accuracy can be fully defended.

XI.—THE MECHANICS OF THE KITE STRING.

Thus far in the study of the behavior of kites, and in the analysis of the forces acting thereon, we have considered only

the kite with a short piece of string or restraining line immediately next to it. We now wish to study the forces acting upon the line, with a view to clearly setting forth in what manner and to what extent these forces limit the elevation attainable with a given kite and the position it assumes.

If we could employ a string or wire having no weight, and so fine that the pressure of the wind upon it would be wholly inappreciable, then, as more and more of this wire is paid out to it, the kite would pass outward and upward along the same straight line, such as $R K$, Fig. 21, retaining always the same

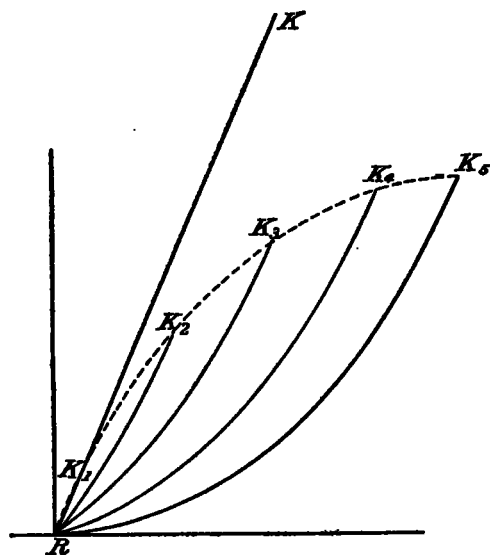

FIG. 21.

angular elevation as seen from the reel. Provided the wind continued unchanged in force, there would be no limit to the height to which a kite could be flown under such circumstances. Unfortunately, however, we can not fly kites with wire having no weight, and against which the wind will not press, and, in consequence, our actual kite behaves in a very different manner from that described above. Supposing, as before, that the wind force is the same at all points, high or low, the results actually obtained with the kite above employed will be something like the following: When but a short length of wire is paid out to the kite, it will take its position upon the same line, $R K$, as before; that is, for example, at K_1 . When more wire is unreeled, the kite does not continue upward on this line, but, instead, drifts gradually away to leeward and assumes, successively, such positions as at K_2 , K_3 , K_4 , etc., which positions lie on a curve identical with that of the line, but having the ends and sags reversed. An important feature, common to all of the positions the kite may assume, is that the portion of the wire next the kite remains always at exactly the same inclination. The inclination is not only the same for all positions, but is the same as it originally was at $R K_1$. Changes of the wind force and other influences may cause this inclination of the wire to change, but the mere reeling out or in of the wire itself has no effect on the inclination. With a certain amount of wire out, the portion next the reel becomes horizontal, and the limit of altitude is then reached. The kite can lift no more line. All these effects have been brought about under the limitations imposed by the action of gravity and the wind upon the wire. We have mentioned the wind equally with gravity as affecting the wire. It is probable that with moderate wind forces the pressure upon wire, owing to its fineness in proportion to its weight and strength, is a smaller and less important force than gravity. With a given weight of line the maximum of strength and the minimum of wind effect are obtained by the use of tempered steel music wire.

By the aid of well-known mathematical formulæ we can determine in the most complete and exact manner all the effects due to the action of gravity on the wire. On the other hand, the effects of the combined action of wind and gravity are of a very complex character, and but little known and understood and can be mathematically represented only in a most general and imperfect manner. The effect of the wind pressure on the wire will be disregarded in the present treatment, and we will proceed to develop the properties of the curve assumed by the kite wire, as if it were dependent upon gravity alone.

XII.—PROPERTIES OF THE CATENARY.

The catenary, which is approximately the curve assumed by a kite line of steel wire, possesses many very remarkable and interesting properties that have a more or less important bearing upon the art of flying kites. A comparatively full discussion of these will be found in the published account of Weather Bureau work. We will reproduce here only a few of the most important equations.

The fundamental equations of the catenary may be written in a variety of forms, depending upon the variables employed. Each equation expresses some interesting property of the curve. Some of the forms most convenient for use are the following:

$$y = \sqrt{s^2 + c^2} - c \tag{1}$$

$$x = c \operatorname{nap} \log \frac{s + \sqrt{s^2 + c^2}}{c} \tag{2}$$

$$\tan \theta = \frac{s}{c} = \frac{dy}{dx} \tag{3}$$

$$t = w(c + y) \tag{4}$$

In these equations x is measured horizontally and y vertically, and the origin of coordinates is taken at the point where the curve is horizontal; s is the length of the curve measured from the origin; c is a constant; θ is the angle of inclination of the curve to the horizon at the upper end of a portion of length s ; t is the tension at this upper end, and w is the weight per unit length of the material of which the catenary is formed.

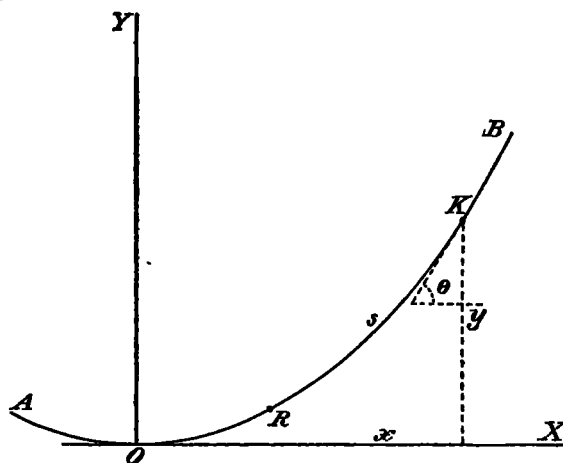

FIG. 22.

In Fig. 22 let $A O B$ represent a catenary. The curve has similar branches on either side of $O Y$, but we are generally concerned with only a portion of the curve on one side. If the wire at the reel is just horizontal, then the position of the reel will be represented by the point O in the diagram. If the wire at the reel is inclined upward, more or less, then the position of the reel will be represented on the diagram by some such point as R , at which point the curve is inclined at the same angle as the wire at the reel.

Tension.—The quantity c , in the equation above, is given by the expression $c = \frac{t_0}{w}$. That is, c is the length of a piece of wire whose weight equals t_0 , the tension in the curve at the lowest point, where x, y, s , and θ are all zero.

If t, θ and t', θ' are, respectively, the tensions and inclinations of the curve at any two points, then, from equations (1), (3), and (4), there results,

$$\frac{t}{t'} = \frac{\cos \theta'}{\cos \theta} \tag{5}$$

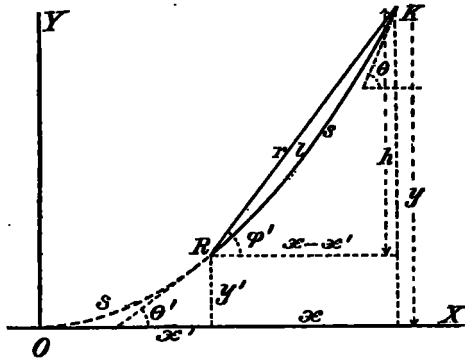

FIG. 23.

General equations for partial ascensions.—Fig. 23 represents a partial ascension in which the reel is at R and the kite at K , with the origin of coordinates at O . Letters designating the coordinates of the catenary at the point representing the reel are distinguished by a superscript ($'$). The linear elevation of the kite is $h = y - y'$ and the length of wire out is $l = s - s'$.

If t' is the tension of the wire at the reel, then the linear height of the point R above the origin of coordinates is given by the equation

$$y' = \frac{t'}{w} (1 - \cos \theta')$$

The length of the catenary from R to the origin is

$$s' = \frac{t'}{w} \sin \theta'$$

Eliminating c from equation (1) by its value in terms of t' and θ' and replacing s by its value $s = l + \frac{t'}{w} \sin \theta'$ we obtain,

$$y = \sqrt{l^2 + \frac{2lt'}{w} \sin \theta' + \left(\frac{t'}{w}\right)^2} - \frac{t'}{w} \cos \theta'$$

Whence,

$$h = y - y' = \sqrt{l^2 + \frac{2lt'}{w} \sin \theta' + \left(\frac{t'}{w}\right)^2} - \frac{t'}{w} \tag{6}$$

That is, when the length of wire out is known, together with the tension and inclination at the reel, we may deduce the height of the kite, even when it is concealed from view, as by clouds, darkness, its remote distance, etc. This results from a general property of the catenary and the equation is equally applicable to the case of either partial or complete ascensions. Owing to great momentary variations that take place in the tension of the wire the calculations of elevations depending upon the tension at the reel will not, as a rule, be as accurate as those deduced by other methods, but equation (6) will undoubtedly prove useful in cases where other methods of ascertaining elevation are not available.

The elevation of an invisible kite deduced by equation (6) will be more accurate as the sag in the wire is greater.

If θ and t are the inclination and tension of the wire at the kite, we may write,

$$y = \frac{t}{w} (1 - \cos \theta), \text{ and } y' = \frac{t'}{w} (1 - \cos \theta')$$

whence, by equation (5), we get,

$$h = y - y' = \frac{t}{w} \left(1 - \frac{\cos \theta}{\cos \theta'}\right) = r \sin \phi' \tag{7}$$

Slack in the wire in partial ascensions.—Let r be the length of the chord of the catenary from the reel to the kite, and ϕ' the angular elevation of the kite from the reel, then,

$$r = \frac{h}{\sin \phi'}$$

$$\text{slack} = l - r \text{ and percentage of slack} = 1 - \frac{r}{l}$$

The ratio of any chord of a catenary to the corresponding arc is given by the equation

$$\frac{r}{l} = \frac{\cos \theta' - \cos \theta}{\sin \phi' \sin (\theta - \theta')} \tag{8}$$

which may be obtained from equation (7) by eliminating $\frac{t}{w}$ in terms of l .

The relation between ϕ', θ , and θ' is obtained from equation (2) together with the value of h in (7), thus,

$$\tan \phi' = \frac{h}{x - x'} = \frac{\sec \theta - \sec \theta'}{\text{nap log} \left[\frac{\sec \theta + \tan \theta}{\sec \theta' + \tan \theta'} \right]} \tag{9}$$

In this equation ϕ' is the angular elevation of the kite, as seen from the reel.

The following table contains a series of values of ϕ' deduced from equation (9) corresponding to such assumed values of θ and θ' as may occur in practice. With each value of ϕ' is also tabulated the corresponding percentage of slack computed by means of equation (7). The results are rigorous representations of the properties of the catenary, and even though the wind effect has been omitted, the relations of the quantities concerned are such that the wind effect on the wire can not modify the percentage of slack, corresponding to given values of ϕ' and θ' , except by a quantity of secondary magnitude.

Angular elevation and percentage of slack.

Inclination of wire at kite.	θ' = Inclination of wire at reel.						
	0°	10°	20°	30°	40°	50°	60°
$\theta = 50^\circ$ { Slack, per cent.	3.23	2.08	1.11	0.51	0.18
ϕ'	28.8°	32.9°	36.9°	41.0°	45.3°
$\theta = 55^\circ$ { Slack, per cent.	3.87	2.55	1.53	0.78	0.29	0.08
ϕ'	32.8°	36.6°	40.4°	44.2°	48.2°	52.5°
$\theta = 60^\circ$ { Slack, per cent.	4.53	3.10	1.97	1.11	0.50	0.13
ϕ'	37.2°	40.8°	44.3°	47.8°	51.4°	55.4°
$\theta = 65^\circ$ { Slack, per cent.	5.17	3.65	2.43	1.48	0.76	0.23	0.08
ϕ'	42.2°	45.4°	48.5°	51.7°	55.0°	58.5°	62.6°

Elevation attainable.—It is desirable to know how much pull and what length of line is necessary in a given case to reach a certain elevation, that is, to sustain the wire from the kite down to the reel. The pull may be deduced by solving equation (7) for t . The length of line required may be found by the equation,

$$l = \frac{t}{w} (\sin \theta - \cos \theta \tan \theta')$$

The steel wire used as kite line by the writer is 0.0285 of an inch in diameter and weighs 2.155 pounds per 1,000 feet. The table below gives the pull and the amount of line required to reach certain elevations, depending upon the inclination θ , at which the kite pulls the wire and also the angle θ' , to which the wire is permitted to sag at the reel. The wind effect on the wire is neglected, and necessarily so from our present ignorance of the numerical magnitude of these effects. The results are, therefore, not exactly representative of actual kite ascensions. The discrepancies will be small in moderate winds, that is, under 20 miles per hour, but become more important at this and higher velocities.

Essential elements in kite ascension.

$$w = 2.155 \text{ lbs. per 1,000 ft.}$$

$$l = \frac{wh}{1 - \frac{\cos \theta}{\cos \theta'}} \quad l = \frac{t}{w} (\sin \theta - \cos \theta \tan \theta')$$

h.	θ'	$\theta=50^\circ$		$\theta=60^\circ$		$\theta=70^\circ$	
		l	t	l	t	l	t
2,000	$\theta'=10^\circ$	3,766	12.4	3,163	8.8	2,693	6.6
	$\theta'=20^\circ$	3,367	13.6	2,926	9.2	2,565	6.8
4,000	$\theta'=10^\circ$	7,511	24.8	6,324	17.5	5,386	13.2
	$\theta'=20^\circ$	6,739	27.3	5,853	18.4	5,130	13.6
6,000	$\theta'=10^\circ$	11,267	37.2	9,485	26.3	8,090	19.8
	$\theta'=20^\circ$	10,102	40.9	8,779	27.6	7,694	20.3
8,000	$\theta'=10^\circ$	15,022	49.6	12,047	35.0	10,773	26.4
	$\theta'=20^\circ$	13,469	54.6	11,706	36.8	10,259	27.1
10,000	$\theta'=10^\circ$	18,778	62.0	15,809	43.8	13,466	33.0
	$\theta'=20^\circ$	16,885	65.2	14,632	46.1	12,824	33.9

It is asked "What is the difference in effect between the kite string and the attraction of gravity on the mass of a soaring bird?"

The effects are very different in many respects. In the first place the string constrains its kite to move in a certain definite surface of constraint which, in general, is sensibly a spherical surface. Gravity does not exercise any similar constraint upon the bird. Secondly, the tension or pull of the string may act in many different directions, and with a magnitude which depends almost entirely upon the pressure of the wind upon the kite; that is, if the wind suddenly stops blowing, the string will quite as suddenly slacken up entirely and the feeble pull it exerts due to its direct weight will be in a new direction, and will often be but a small fraction of its original pull. The tension in the string is not a *primary* but a dependent force. The force of gravity on the bird is, however, a primary force, is always constant in amount, and its direction of action is always vertical. We do not consider that there is any real mechanical analogy between the effects of the force of gravity on a bird and the pull of the string of a kite. Without the restraint of the string the kite and the bird are similar in that both are subject to the attraction of gravity, and both expose certain surfaces to the action of the wind. The kite completely lacks the intelligence or instinct of the bird, but stable forms of tailless kites cast adrift in the wind are carried long distances before reaching the ground. Two large Hargrave kites broke away from the writer in a violent rainstorm when at a height of about 7,000 feet. The total supporting surface was about 80 square feet, and the weight 8 pounds plus the effects of rain and several pounds of wire. These kites drifted 15 miles before reaching the ground and descended entirely uninjured.

NOTES BY THE EDITOR.

SEASONAL FORECASTS FOR OREGON.

On the morning weather map of April 12, published at Portland, Oreg., Mr. B. S. Pague, Local Forecast Official, says:

The first summer type of weather conditions appeared Saturday night and Sunday and continues this morning. The appearance of this type marks the commencement of the summer or dry season and the passage of the winter or wet season. From now on until the first appearance of the winter conditions next autumn, fair weather is more probable than rainy weather. Summer conditions do not mean absolute dryness, but rather fewer rainy periods, more sunshine, and more warmth.

In 1895, the first appearance of summer conditions appeared on April 20; rain fell in that year from April 30 to May 9 in showers, and again from May 20 to May 30, the total being 3.42 inches. June had rain on two days. May was cool, and June had normal temperatures.

In 1896, summer conditions did not appear until June 13, and then, except a few sprinkles, no rain fell until August 1, when showers occurred for five days.

Winter conditions appeared in 1895 on November 12, and in 1896 on October 20. Frosts west of the Cascades are not, as a rule, injurious after the appearance of summer weather conditions.

Summer conditions are distinguished from winter by the movement of the areas of high and low pressures. In the summer the highs move from off the central California coast northward along the coast to about 50° north latitude, thence eastward. Cool weather appears when the high is between Cape Mendocino and the Columbia River, and it is warmer when the high is moving over the Coast and Cascade ranges. The warmest occurs when the high is to the northeast of Spokane. Under the summer conditions, the low areas retreat to the north and pass eastward about the latitude of Sitka; for this reason, summer rains prevail in Alaska.

CLOUD HEIGHTS—A PROBLEM FOR STUDENTS.

On a preceding page we have published Mr. H. H. Clayton's modification of Feussner's method of computing the height of a cloud by observations of the location of its shadow.

This modification consists essentially in applying the double or check computation first extensively introduced by Ekholm and Hagstrom into the so-called parallactic method. The formulæ for the computation are essentially the same as were arranged a year ago by Professor Bigelow for use at the Weather Bureau, in reducing simultaneous cloud observations made at the two ends of a fixed base line.

As the trigonometrical relations are very simple it is to be hoped that many of our intelligent observers will interest themselves in determining frequently the actual heights and motions of the clouds. There are many methods of doing this and these together with new ones that yet remain to be invented, constitute problems that may well interest every youth when studying trigonometry and its practical applications. Such problems should be explained in our high schools and colleges generally, as an interesting practical example of the use of trigonometry. It is customary for our universities to require special original work from those who are candidates for the higher degrees, such as B. S., M. S., D. S., C. E., A. M., Ph. D., etc. To those candidates who are interested in the atmosphere and terrestrial physics we earnestly recommend the study of the clouds, their altitudes, motions, and laws of formation as a thoroughly appropriate problem and one of the greatest importance to meteorology. The following special deduction of Ekholm's formulæ, as needed in Feussner's method, will interest such students. Nearly all the known methods are enumerated in the Editor's Treatise on Meteorological Apparatus and Methods, Washington, 1887, except that based on the use of the nephoscope at sea, which has been elaborated since then by Finemann and the Editor. Doubtless other methods remain to be in-